

## Tiny 1.5A, High-Speed Power MOSFET Driver

### Features

- High Peak Output Current: 1.5A (typical)
- Wide Input Supply Voltage Operating Range:
  - 4.5V to 18V
- Low Shoot-Through/Cross-Conduction Current in Output Stage
- High Capacitive Load Drive Capability:
  - 470 pF in 13 ns (typical)
  - 1000 pF in 20 ns (typical)
- Short Delay Times: 41 ns ( $t_{D1}$ ), 48 ns ( $t_{D2}$ ) (typical)
- Low Supply Current:
  - With Logic '1' Input - 0.65 mA (typical)
  - With Logic '0' Input - 0.1 mA (typical)
- Latch-Up Protected: Will Withstand 500 mA Reverse Current
- Logic Input Will Withstand Negative Swing Up To 5V
- Space-saving 5L SOT-23 Package

### Applications

- Switch Mode Power Supplies
- Pulse Transformer Drive
- Line Drivers
- Level Translator
- Motor and Solenoid Drive

### General Description

The MCP1415/16 are high speed MOSFET drivers capable of providing 1.5A of peak current. The inverting or non-inverting single channel output is directly controlled from either TTL or CMOS (3V to 18V) logic. These devices also feature low shoot-through current, matched rise and fall time, and short propagation delays which make them ideal for high switching frequency applications.

The MCP1415/16 devices operate from a single 4.5V to 18V power supply and can easily charge and discharge 1000 pF gate capacitance in under 20 ns (typical). They provide low enough impedances in both the on and off states to ensure the intended state of the MOSFET will not be affected, even by large transients.

These devices are highly latch-up resistant under any condition within their power and voltage ratings. They are not subject to damage when up to 5V of noise spiking (of either polarity) occurs on the ground pin. They can accept, without damage or logic upset, up to 500 mA of reverse current being forced back into their outputs. All terminals are fully protected against Electrostatic Discharge (ESD) up to 2.0 kV (HBM) and 400V (MM).

### Package Types:

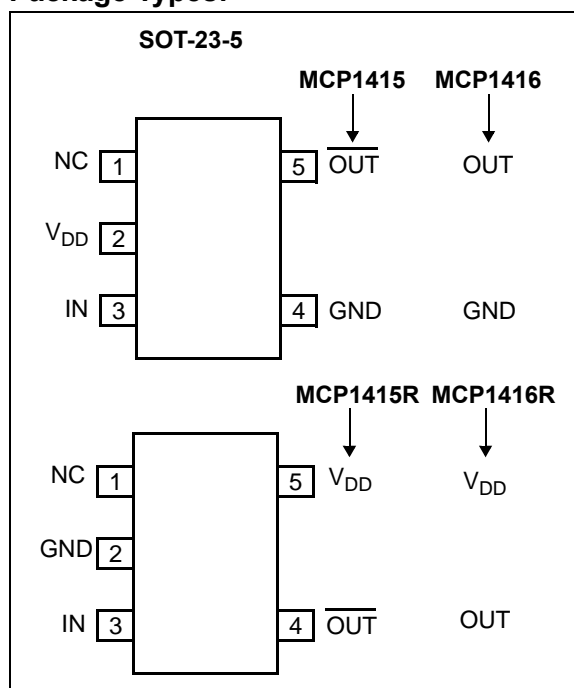

# MCP1415/16

## Functional Block Diagram

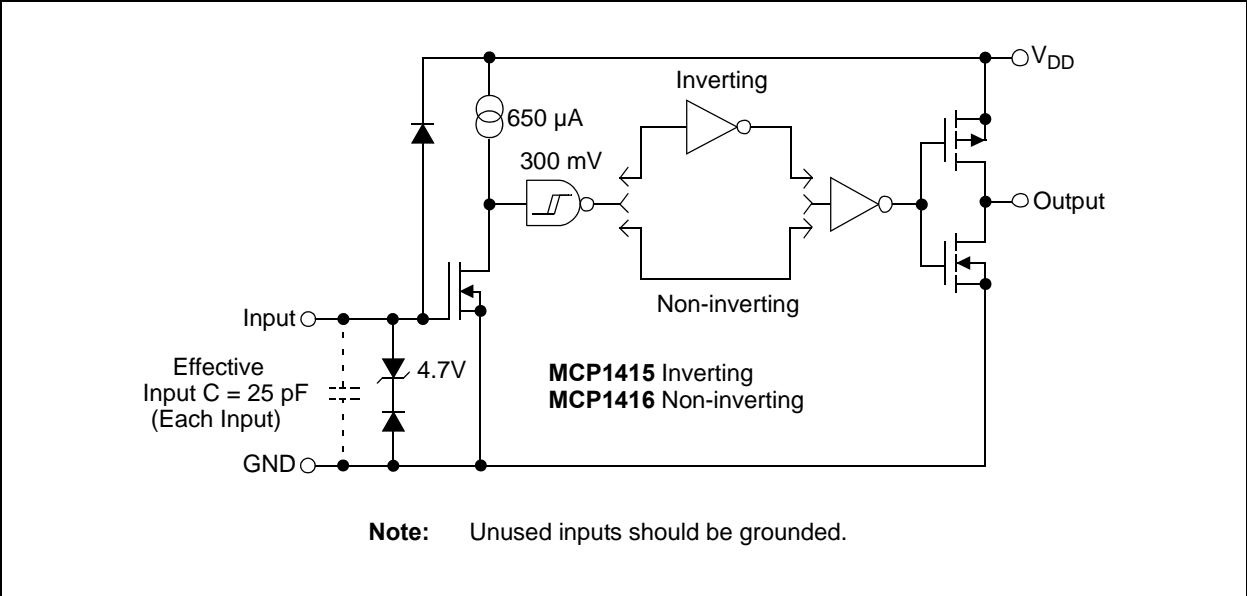

## 1.0 ELECTRICAL CHARACTERISTICS

### Absolute Maximum Ratings †

V <sub>DD</sub> , Supply Voltage.....	+20V
V <sub>IN</sub> , Input Voltage.....(V <sub>DD</sub> + 0.3V) to (GND - 5V)	
Package Power Dissipation (T <sub>A</sub> = 50°C)	
5L SOT23.....	0.39W
ESD Protection on all Pins.....	2.0 kV (HBM)
.....	400V (MM)

† **Notice:** Stresses above those listed under "Maximum Ratings" may cause permanent damage to the device. This is a stress rating only and functional operation of the device at those or any other conditions above those indicated in the operational sections of this specification is not intended. Exposure to maximum rating conditions for extended periods may affect device reliability.

### DC CHARACTERISTICS

Electrical Specifications: Unless otherwise noted, T <sub>A</sub> = +25°C, with 4.5V ≤ V <sub>DD</sub> ≤ 18V						
Parameters	Sym	Min	Typ	Max	Units	Conditions
<b>Input</b>						
Logic '1' High Input Voltage	V <sub>IH</sub>	2.4	1.9	—	V	
Logic '0' Low Input Voltage	V <sub>IL</sub>	—	1.6	0.8	V	
Input Current	I <sub>IN</sub>	-1	—	+1	μA	0V ≤ V <sub>IN</sub> ≤ V <sub>DD</sub>
Input Voltage	V <sub>IN</sub>	-5	—	V <sub>DD</sub> +0.3	V	
<b>Output</b>						
High Output Voltage	V <sub>OH</sub>	V <sub>DD</sub> - 0.025	—	—	V	DC Test
Low Output Voltage	V <sub>OL</sub>	—	—	0.025	V	DC Test
Output Resistance, High	R <sub>OH</sub>	—	6	7.5	Ω	I <sub>OUT</sub> = 10 mA, V <sub>DD</sub> = 18V <b>(Note 2)</b>
Output Resistance, Low	R <sub>OL</sub>	—	4	5.5	Ω	I <sub>OUT</sub> = 10 mA, V <sub>DD</sub> = 18V <b>(Note 2)</b>
Peak Output Current	I <sub>PK</sub>	—	1.5	—	A	V <sub>DD</sub> = 18V <b>(Note 2)</b>
Latch-Up Protection Withstand Reverse Current	I <sub>REV</sub>	0.5	—	—	A	Duty cycle ≤ 2%, t ≤ 300 μs <b>(Note 2)</b>
<b>Switching Time (Note 1)</b>						
Rise Time	t <sub>R</sub>	—	20	25	ns	Figure 4-1, Figure 4-2 C <sub>L</sub> = 1000 pF <b>(Note 2)</b>
Fall Time	t <sub>F</sub>	—	20	25	ns	Figure 4-1, Figure 4-2 C <sub>L</sub> = 1000 pF <b>(Note 2)</b>
Delay Time	t <sub>D1</sub>	—	41	50	ns	Figure 4-1, Figure 4-2 <b>(Note 2)</b>
Delay Time	t <sub>D2</sub>	—	48	55	ns	Figure 4-1, Figure 4-2 <b>(Note 2)</b>
<b>Power Supply</b>						
Supply Voltage	V <sub>DD</sub>	4.5	—	18	V	
Power Supply Current	I <sub>S</sub>	—	0.65	1.1	mA	V <sub>IN</sub> = 3V
	I <sub>S</sub>	—	0.1	0.15	mA	V <sub>IN</sub> = 0V

**Note 1:** Switching times ensured by design.

**Note 2:** Tested during characterization, not production tested.

# MCP1415/16

## DC CHARACTERISTICS (OVER OPERATING TEMPERATURE RANGE)

Electrical Specifications: Unless otherwise indicated, over operating range with $4.5V \leq V_{DD} \leq 18V$ .						
Parameters	Sym	Min	Typ	Max	Units	Conditions
<b>Input</b>						
Logic '1', High Input Voltage	$V_{IH}$	2.4	—	—	V	
Logic '0', Low Input Voltage	$V_{IL}$	—	—	0.8	V	
Input Current	$I_{IN}$	-10	—	+10	$\mu A$	$0V \leq V_{IN} \leq V_{DD}$
Input Voltage	$V_{IN}$	-5	—	$V_{DD}+0.3$	V	
<b>Output</b>						
High Output Voltage	$V_{OH}$	$V_{DD} - 0.025$	—	—	V	DC Test
Low Output Voltage	$V_{OL}$	—	—	0.025	V	DC Test
Output Resistance, High	$R_{OH}$	—	8.5	9.5	$\Omega$	$I_{OUT} = 10 \text{ mA}$ , $V_{DD} = 18V$ (Note 2)
Output Resistance, Low	$R_{OL}$	—	6	7	$\Omega$	$I_{OUT} = 10 \text{ mA}$ , $V_{DD} = 18V$ (Note 2)
<b>Switching Time (Note 1)</b>						
Rise Time	$t_R$	—	30	40	ns	Figure 4-1, Figure 4-2 $C_L = 1000 \text{ pF}$ (Note 2)
Fall Time	$t_F$	—	30	40	ns	Figure 4-1, Figure 4-2 $C_L = 1000 \text{ pF}$ (Note 2)
Delay Time	$t_{D1}$	—	45	55	ns	Figure 4-1, Figure 4-2 (Note 2)
Delay Time	$t_{D2}$	—	50	60		Figure 4-1, Figure 4-2 (Note 2)
<b>Power Supply</b>						
Supply Voltage	$V_{DD}$	4.5	—	18	V	
Power Supply Current	$I_S$	—	0.75	1.5	mA	$V_{IN} = 3.0V$
	$I_S$	—	0.15	0.25	mA	$V_{IN} = 0V$

**Note 1:** Switching times ensured by design.  
**Note 2:** Tested during characterization, not production tested.

## TEMPERATURE CHARACTERISTICS

Electrical Specifications: Unless otherwise noted, all parameters apply with $4.5V \leq V_{DD} \leq 18V$						
Parameter	Sym	Min	Typ	Max	Units	Comments
<b>Temperature Ranges</b>						
Specified Temperature Range	$T_A$	-40	—	+125	$^{\circ}C$	
Maximum Junction Temperature	$T_J$	—	—	+150	$^{\circ}C$	
Storage Temperature Range	$T_A$	-65	—	+150	$^{\circ}C$	
<b>Package Thermal Resistances</b>						
Thermal Resistance, 5LD SOT23	$\theta_{JA}$	—	256	—	$^{\circ}C/W$	

## 2.0 TYPICAL PERFORMANCE CURVES

**Note:** The graphs and tables provided following this note are a statistical summary based on a limited number of samples and are provided for informational purposes only. The performance characteristics listed herein are not tested or guaranteed. In some graphs or tables, the data presented may be outside the specified operating range (e.g., outside specified power supply range) and therefore outside the warranted range.

**Note:** Unless otherwise indicated,  $T_A = +25^\circ\text{C}$  with  $4.5\text{V} \leq V_{DD} \leq 18\text{V}$ .

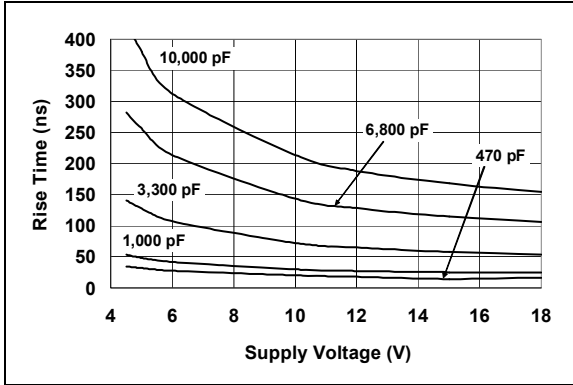

**FIGURE 2-1:** Rise Time vs. Supply Voltage.

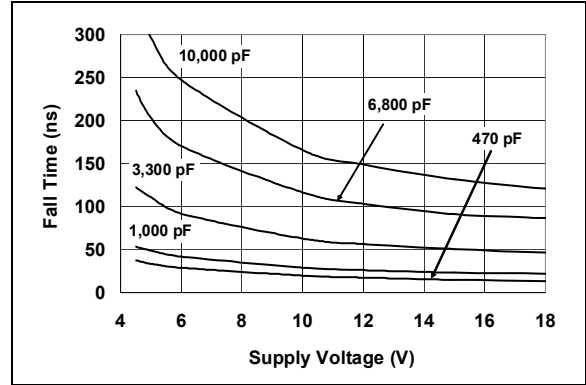

**FIGURE 2-4:** Fall Time vs. Supply Voltage.

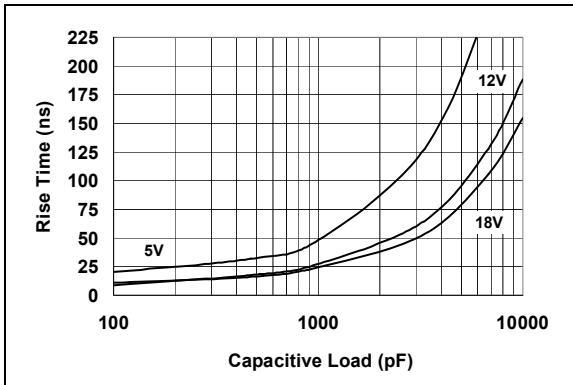

**FIGURE 2-2:** Rise Time vs. Capacitive Load.

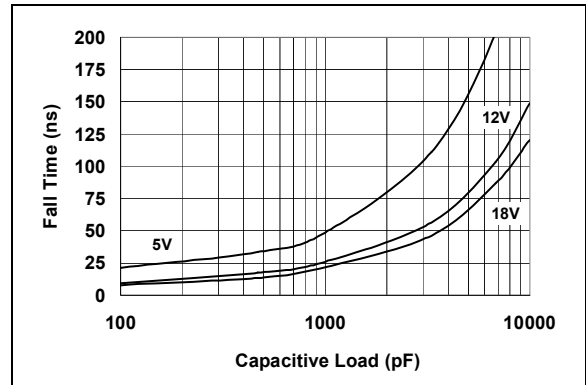

**FIGURE 2-5:** Fall Time vs. Capacitive Load.

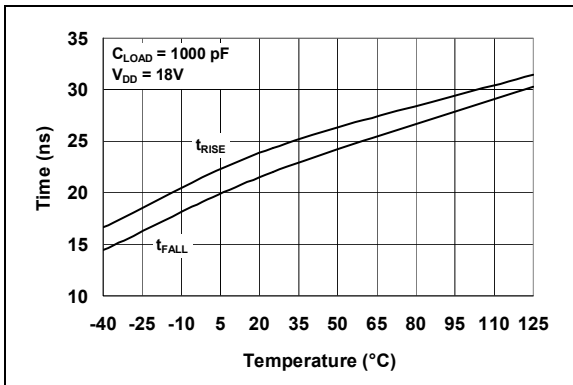

**FIGURE 2-3:** Rise and Fall Times vs. Temperature.

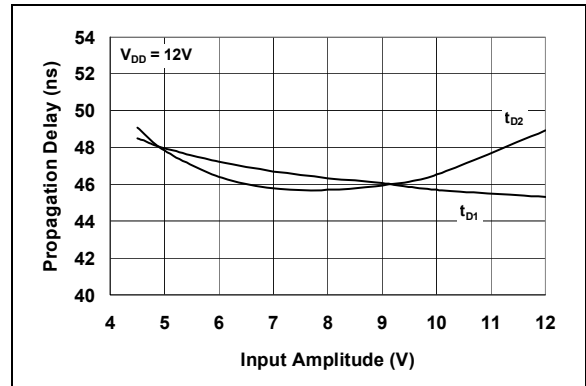
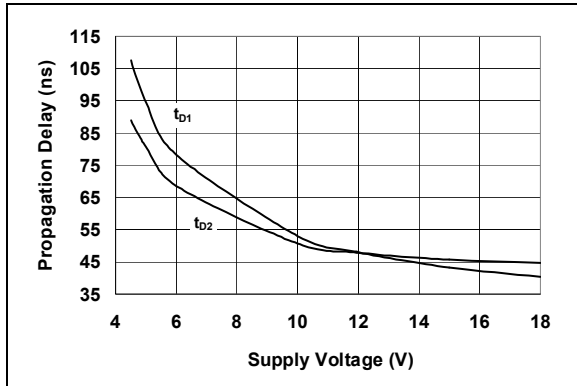

**FIGURE 2-6:** Propagation Delay Time vs. Input Amplitude.

# MCP1415/16

## Typical Performance Curves (Continued)

Note: Unless otherwise indicated,  $T_A = +25^\circ\text{C}$  with  $4.5\text{V} \leq V_{DD} \leq 18\text{V}$ .



**FIGURE 2-7:** Propagation Delay Time vs. Supply Voltage.

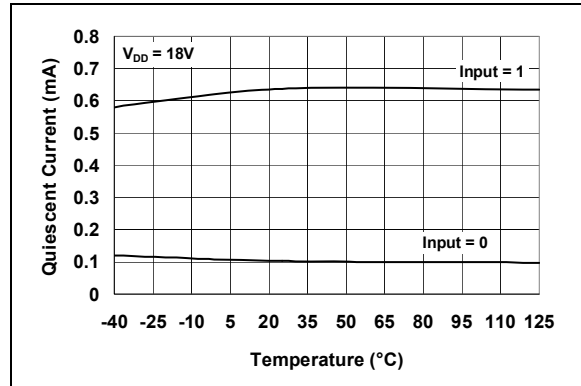

**FIGURE 2-10:** Quiescent Current vs. Temperature.

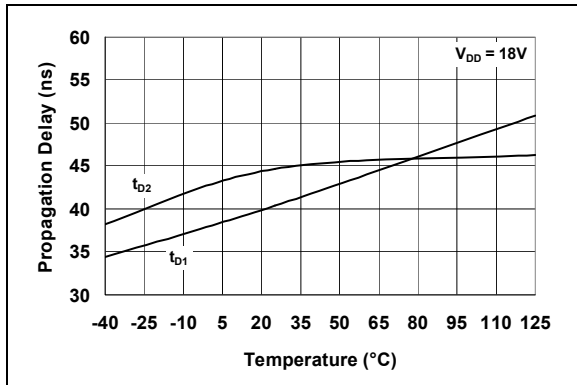

**FIGURE 2-8:** Propagation Delay Time vs. Temperature.

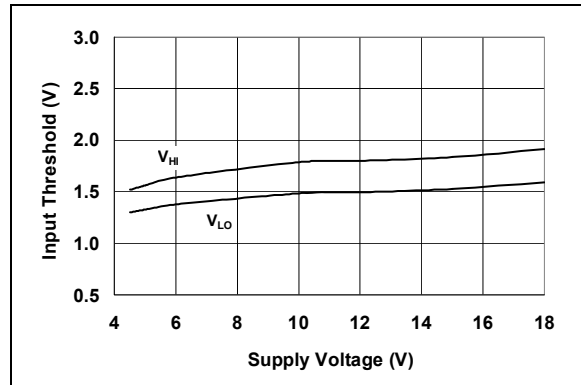

**FIGURE 2-11:** Input Threshold vs. Supply Voltage.

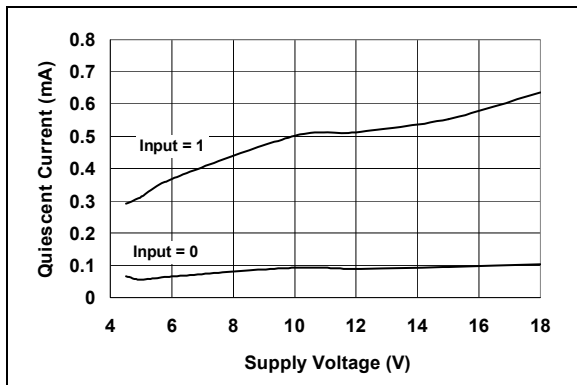

**FIGURE 2-9:** Quiescent Current vs. Supply Voltage.

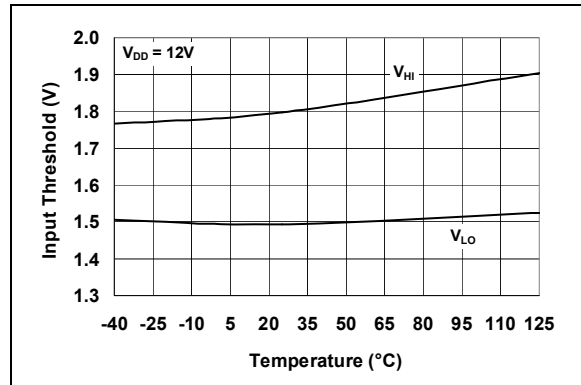

**FIGURE 2-12:** Input Threshold vs. Temperature.

## Typical Performance Curves (Continued)

Note: Unless otherwise indicated,  $T_A = +25^\circ\text{C}$  with  $4.5\text{V} \leq V_{DD} \leq 18\text{V}$ .

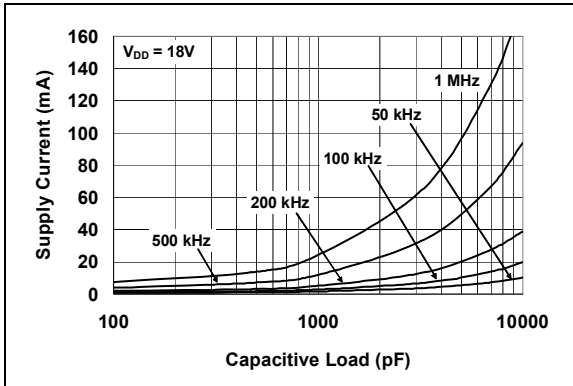

**FIGURE 2-13:** Supply Current vs. Capacitive Load.

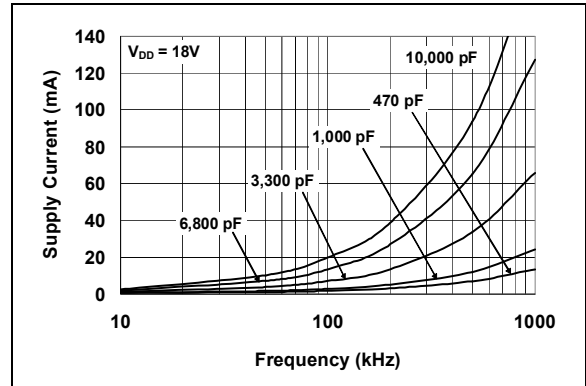

**FIGURE 2-16:** Supply Current vs. Frequency.

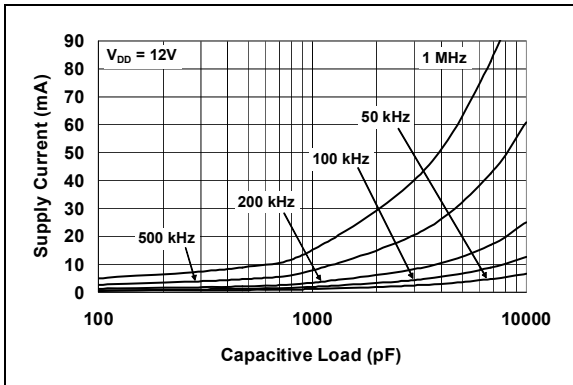

**FIGURE 2-14:** Supply Current vs. Capacitive Load.

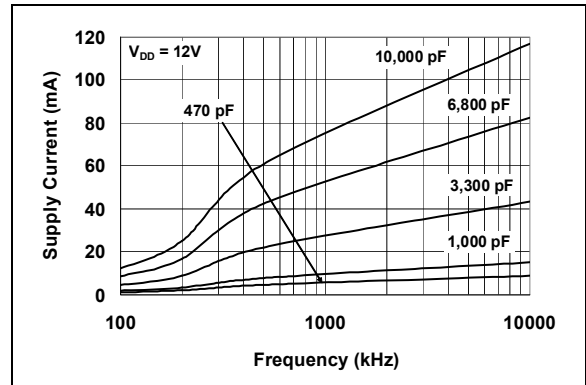

**FIGURE 2-17:** Supply Current vs. Frequency.

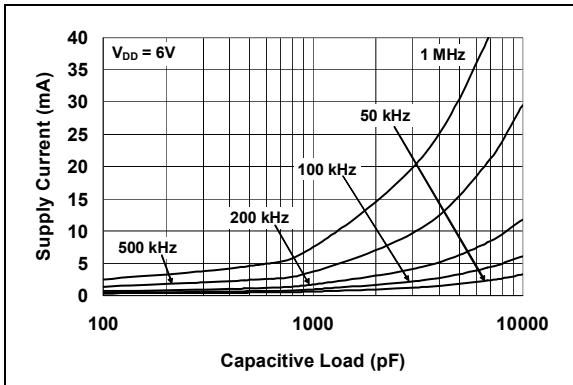

**FIGURE 2-15:** Supply Current vs. Capacitive Load.

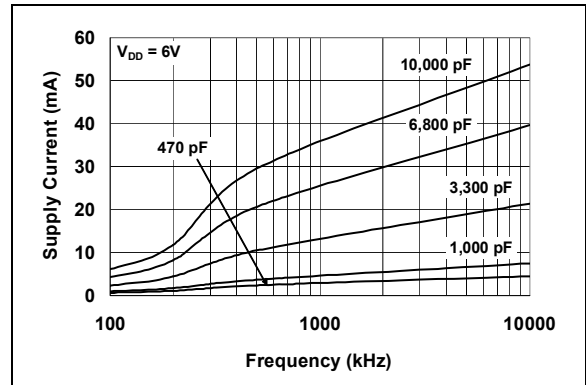
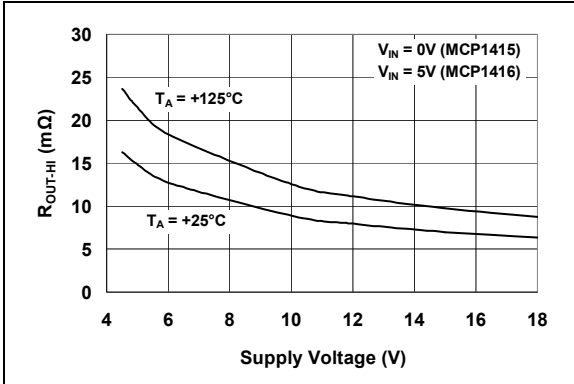

**FIGURE 2-18:** Supply Current vs. Frequency.

# MCP1415/16

## Typical Performance Curves (Continued)

Note: Unless otherwise indicated,  $T_A = +25^\circ\text{C}$  with  $4.5\text{V} \leq V_{DD} \leq 18\text{V}$ .



**FIGURE 2-19:** Output Resistance (Output High) vs. Supply Voltage.

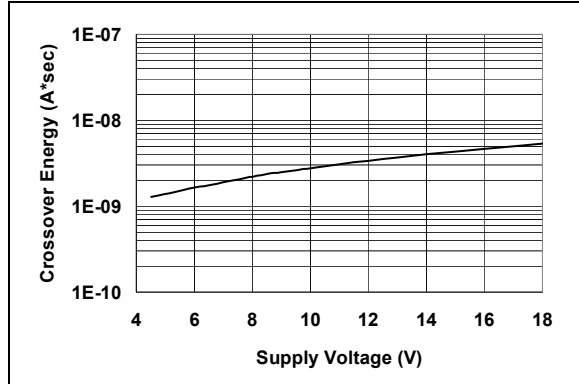

**FIGURE 2-21:** Crossover Energy vs. Supply Voltage.

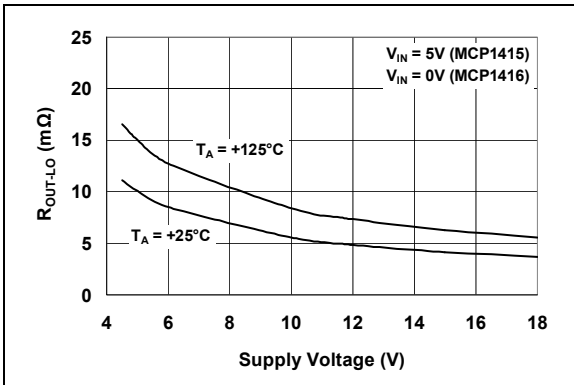

**FIGURE 2-20:** Output Resistance (Output Low) vs. Supply Voltage.



## 3.0 PIN DESCRIPTIONS

The descriptions of the pins are listed in [Table 3-1](#).

**TABLE 3-1: PIN FUNCTION TABLE**

SOT-23-5 Pin	Symbol		Description
	MCP1415/6	MCP1415R/6R	
1	NC	NC	No Connection
2	V <sub>DD</sub>	GND	Supply Input
3	IN	IN	Control Input
4	GND	OUT	Ground
5	OUT	V <sub>DD</sub>	Output

### 3.1 Supply Input (V<sub>DD</sub>)

V<sub>DD</sub> is the bias supply input for the MOSFET driver and has a voltage range of 4.5V to 18V. This input must be decoupled to ground with a local capacitor. This bypass capacitor provides a localized low impedance path for the peak currents that are to be provided to the load.

### 3.2 Control Input (IN)

The MOSFET driver input is a high impedance, TTL/CMOS compatible input. The input also has hysteresis between the high and low input levels, allowing them to be driven from a slow rising and falling signals, and to provide noise immunity.

### 3.3 Ground (GND)

Ground is the device return pin. The ground pin should have a low impedance connection to the bias supply source return. High peak currents will flow out the ground pin when the capacitive load is being discharged.

### 3.4 Output (OUT)

The output is a CMOS push-pull output that is capable of sourcing and sinking 1.5A of peak current (V<sub>DD</sub> = 18V). The low output impedance ensures the gate of the external MOSFET will stay in the intended state even during large transients. This output also has a reverse current latch-up rating of 500 mA.

# MCP1415/16

---

NOTES:

## 4.0 APPLICATION INFORMATION

### 4.1 General Information

MOSFET drivers are high-speed, high current devices which are intended to source/sink high peak currents which are intended to charge/discharge the gate capacitance of external MOSFETs or IGBTs. In high frequency switching power supplies, the PWM controller may not have the drive capability to directly drive the power MOSFET. A MOSFET driver like the MCP1415/16 family can be used to provide additional source/sink current capability.

### 4.2 MOSFET Driver Timing

The ability of a MOSFET driver to transition from a fully off state to a fully on state are characterized by the drivers rise time ( $t_R$ ), fall time ( $t_F$ ), and propagation delays ( $t_{D1}$  and  $t_{D2}$ ). The MCP1415/16 family of drivers can typically charge and discharge a 1000 pF load capacitance in 20 ns along with a typical turn on ( $t_{D1}$ ) propagation delay of 41 ns. [Figure 4-1](#) and [Figure 4-2](#) show the test circuit and timing waveform used to verify the MCP1415/16 timing.

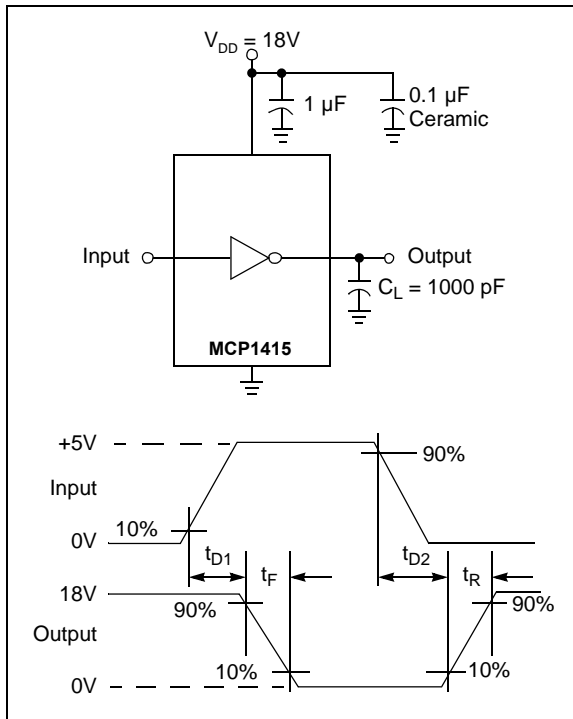

**FIGURE 4-1:** Inverting Driver Timing Waveform.

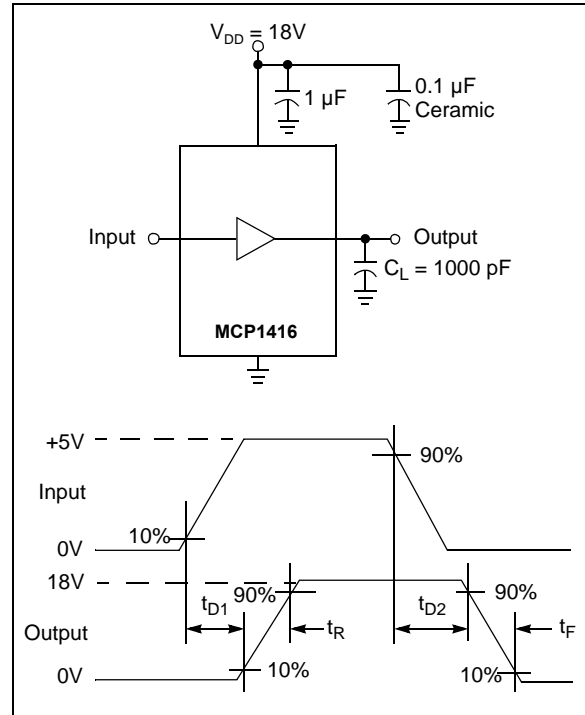

**FIGURE 4-2:** Non-Inverting Driver Timing Waveform.

### 4.3 Decoupling Capacitors

Careful layout and decoupling capacitors are required when using power MOSFET drivers. Large current are required to charge and discharge capacitive loads quickly. For example, approximately 720 mA are needed to charge a 1000 pF load with 18V in 25 ns.

To operate the MOSFET driver over a wide frequency range with low supply impedance, a ceramic and low ESR film capacitor is recommended to be placed in parallel between the driver  $V_{DD}$  and GND. A 1.0 µF low ESR film capacitor and a 0.1 µF ceramic capacitor placed between pins 2 and 4 is required for reliable operation. These capacitors should be placed close to the driver to minimize circuit board parasitics and provide a local source for the required current.

# MCP1415/16

## 4.4 Power Dissipation

The total internal power dissipation in a MOSFET driver is the summation of three separate power dissipation elements.

### EQUATION 4-1:

$$P_T = P_L + P_Q + P_{CC}$$

Where:

$P_T$	=	Total power dissipation
$P_L$	=	Load power dissipation
$P_Q$	=	Quiescent power dissipation
$P_{CC}$	=	Operating power dissipation

### 4.4.1 CAPACITIVE LOAD DISSIPATION

The power dissipation caused by a capacitive load is a direct function of the frequency, total capacitive load, and supply voltage. The power lost in the MOSFET driver for a complete charging and discharging cycle of a MOSFET is shown in Equation 4-2.

### EQUATION 4-2:

$$P_L = f \times C_T \times V_{DD}^2$$

Where:

$f$	=	Switching frequency
$C_T$	=	Total load capacitance
$V_{DD}$	=	MOSFET driver supply voltage

### 4.4.2 QUIESCENT POWER DISSIPATION

The power dissipation associated with the quiescent current draw depends upon the state of the input pin. The MCP1415/16 devices have a quiescent current draw when the input is high of 0.65 mA (typical) and 0.1 mA (typical) when the input is low. The quiescent power dissipation is shown in Equation 4-3.

### EQUATION 4-3:

$$P_Q = (I_{QH} \times D + I_{QL} \times (1 - D)) \times V_{DD}$$

Where:

$I_{QH}$	=	Quiescent current in the high state
$D$	=	Duty cycle
$I_{QL}$	=	Quiescent current in the low state
$V_{DD}$	=	MOSFET driver supply voltage

### 4.4.3 OPERATING POWER DISSIPATION

The operating power dissipation occurs each time the MOSFET driver output transitions because for a very short period of time both MOSFETs in the output stage are on simultaneously. This cross-conduction current leads to a power dissipation describe in Equation 4-4.

### EQUATION 4-4:

$$P_{CC} = CC \times f \times V_{DD}$$

Where:

$CC$	=	Cross-conduction constant (A*sec)
$f$	=	Switching frequency
$V_{DD}$	=	MOSFET driver supply voltage

## 4.5 PCB Layout Considerations

Proper PCB layout is important in high current, fast switching circuits to provide proper device operation and robustness of design. Improper component placement may cause errant switching, excessive voltage ringing, or circuit latch-up. PCB trace loop area and inductance must be minimized. This is accomplished by placing the MOSFET driver directly at the load and placing the bypass capacitor directly at the MOSFET driver (Figure 4-3). Locating ground planes or ground return traces directly beneath the driver output signal also reduces trace inductance. A ground plane will also help as a radiated noise shield as well as providing some heat sinking for power dissipated within the device (Figure 4-4).

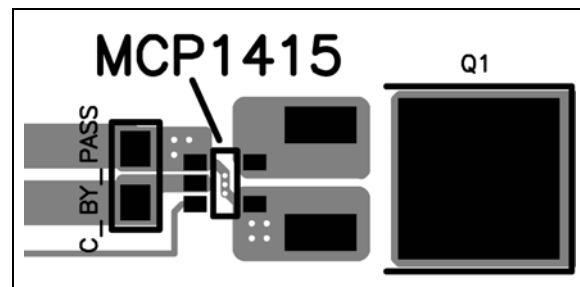

FIGURE 4-3: Recommended PCB Layout (TOP).

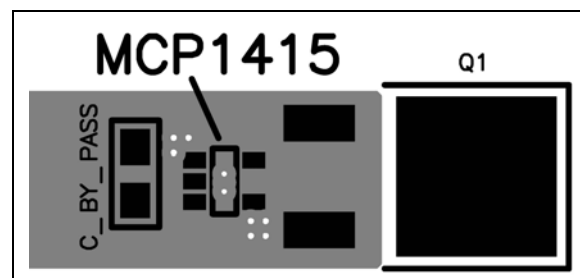
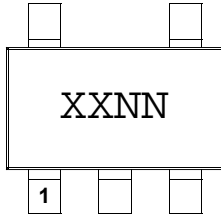

FIGURE 4-4: Recommended PCB Layout (BOTTOM).

## 5.0 PACKAGING INFORMATION

### 5.1 Package Marking Information

5-Lead SOT-23



Standard Markings for SOT-23	
Part Number	Code
MCP1415T-E/OT	FYNN
MCP1416T-E/OT	FZNN
MCP1415RT-E/OT	F7NN
MCP1416RT-E/OT	F8NN

Example:

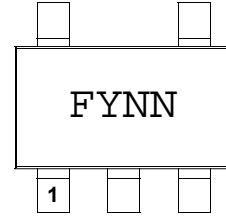

<b>Legend:</b>	XX...X	Customer-specific information
	Y	Year code (last digit of calendar year)
	YY	Year code (last 2 digits of calendar year)
	WW	Week code (week of January 1 is week '01')
	NNN	Alphanumeric traceability code
	(e3)	Pb-free JEDEC designator for Matte Tin (Sn)
	*	This package is Pb-free. The Pb-free JEDEC designator (e3) can be found on the outer packaging for this package.

**Note:** In the event the full Microchip part number cannot be marked on one line, it will be carried over to the next line, thus limiting the number of available characters for customer-specific information.

# MCP1415/16

## 5-Lead Plastic Small Outline Transistor (OT) [SOT-23]

**Note:** For the most current package drawings, please see the Microchip Packaging Specification located at <http://www.microchip.com/packaging>

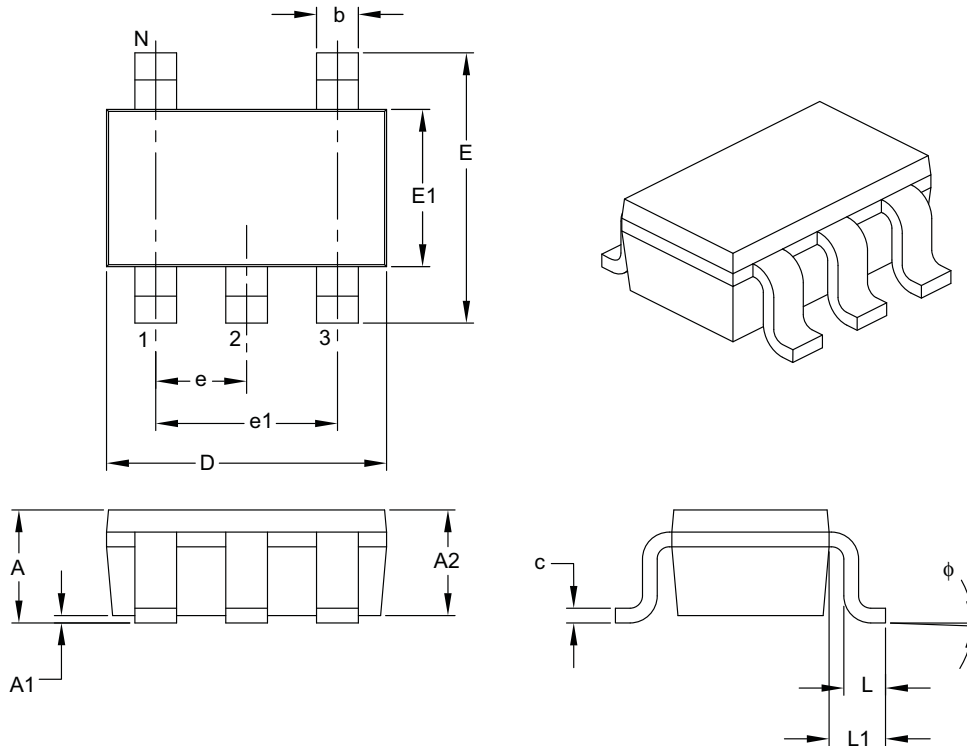

Dimension Limits	Units	MILLIMETERS		
		MIN	NOM	MAX
Number of Pins	N	5		
Lead Pitch	e	0.95 BSC		
Outside Lead Pitch	e1	1.90 BSC		
Overall Height	A	0.90	–	1.45
Molded Package Thickness	A2	0.89	–	1.30
Standoff	A1	0.00	–	0.15
Overall Width	E	2.20	–	3.20
Molded Package Width	E1	1.30	–	1.80
Overall Length	D	2.70	–	3.10
Foot Length	L	0.10	–	0.60
Footprint	L1	0.35	–	0.80
Foot Angle	$\phi$	0°	–	30°
Lead Thickness	c	0.08	–	0.26
Lead Width	b	0.20	–	0.51

**Notes:**

- Dimensions D and E1 do not include mold flash or protrusions. Mold flash or protrusions shall not exceed 0.127 mm per side.
- Dimensioning and tolerancing per ASME Y14.5M.

BSC: Basic Dimension. Theoretically exact value shown without tolerances.

Microchip Technology Drawing C04-091B

## APPENDIX A: REVISION HISTORY

### Revision C (December 2008)

The following is the list of modifications:

1. Added the MCP1415R/16R devices throughout document.

### Revision B (June 2008)

The following is the list of modifications:

1. DC Characteristics table, Switching Time, Rise Time: changed from 13 to 20.
2. DC Characteristics table, Switching Time, Fall Time: changed from 13 to 20.
3. DC Characteristics (Over Operating Temperature Range) table, Switching Time, Rise Time: changed maximum from 35 to 40.
4. DC Characteristics (Over Operating Temperature Range) table, Switching Time, Rise Time: changed typical from 25 to 30.
5. DC Characteristics (Over Operating Temperature Range) table, Switching Time, Fall Time: changed maximum from 35 to 40.
6. DC Characteristics (Over Operating Temperature Range) table, Switching Time, Fall Time: changed typical from 25 to 30.

### Revision A (June 2008)

- Original Release of this Document.

# MCP1415/16

---

NOTES:



## PRODUCT IDENTIFICATION SYSTEM

To order or obtain information, e.g., on pricing or delivery, refer to the factory or the listed sales office.

<u>PART NO.</u>	<u>-X</u>	<u>/XX</u>
Device	Temperature Range	Package
Device: MCP1415T: 1.5A MOSFET Driver, Inverting (Tape and Reel) MCP1415RT: 1.5A MOSFET Driver, Inverting (Tape and Reel) MCP1416T: 1.5A MOSFET Driver, Non-Inverting (Tape and Reel) MCP1416RT: 1.5A MOSFET Driver, Non-Inverting (Tape and Reel)	Temperature Range: E = -40°C to +125°C	Package: *           OT = Plastic Thin Small Outline Transistor (OT), 5-Lead * All package offerings are Pb Free (Lead Free)
<b>Examples:</b> a) MCP1415T-E/OT: 1.5A Inverting, MOSFET Driver 5LD SOT-23 Package b) MCP1415RT-E/OT: 1.5A Inverting, MOSFET Driver 5LD SOT-23 Package a) MCP1416T-E/OT: 1.5A Non-Inverting, MOSFET Driver 5LD SOT-23 Package b) MCP1416RT-E/OT: 1.5A Non-Inverting, MOSFET Driver 5LD SOT-23 Package		

# MCP1415/16

---

NOTES:

---

**Note the following details of the code protection feature on Microchip devices:**

- Microchip products meet the specification contained in their particular Microchip Data Sheet.
- Microchip believes that its family of products is one of the most secure families of its kind on the market today, when used in the intended manner and under normal conditions.
- There are dishonest and possibly illegal methods used to breach the code protection feature. All of these methods, to our knowledge, require using the Microchip products in a manner outside the operating specifications contained in Microchip's Data Sheets. Most likely, the person doing so is engaged in theft of intellectual property.
- Microchip is willing to work with the customer who is concerned about the integrity of their code.
- Neither Microchip nor any other semiconductor manufacturer can guarantee the security of their code. Code protection does not mean that we are guaranteeing the product as “unbreakable.”

Code protection is constantly evolving. We at Microchip are committed to continuously improving the code protection features of our products. Attempts to break Microchip's code protection feature may be a violation of the Digital Millennium Copyright Act. If such acts allow unauthorized access to your software or other copyrighted work, you may have a right to sue for relief under that Act.

---

Information contained in this publication regarding device applications and the like is provided only for your convenience and may be superseded by updates. It is your responsibility to ensure that your application meets with your specifications. MICROCHIP MAKES NO REPRESENTATIONS OR WARRANTIES OF ANY KIND WHETHER EXPRESS OR IMPLIED, WRITTEN OR ORAL, STATUTORY OR OTHERWISE, RELATED TO THE INFORMATION, INCLUDING BUT NOT LIMITED TO ITS CONDITION, QUALITY, PERFORMANCE, MERCHANTABILITY OR FITNESS FOR PURPOSE. Microchip disclaims all liability arising from this information and its use. Use of Microchip devices in life support and/or safety applications is entirely at the buyer's risk, and the buyer agrees to defend, indemnify and hold harmless Microchip from any and all damages, claims, suits, or expenses resulting from such use. No licenses are conveyed, implicitly or otherwise, under any Microchip intellectual property rights.

**Trademarks**

The Microchip name and logo, the Microchip logo, Accuron, dsPIC, KEELOQ, KEELOQ logo, MPLAB, PIC, PICmicro, PICSTART, rfPIC, SmartShunt and UNI/O are registered trademarks of Microchip Technology Incorporated in the U.S.A. and other countries.

FilterLab, Linear Active Thermistor, MXDEV, MXLAB, SEEVAL, SmartSensor and The Embedded Control Solutions Company are registered trademarks of Microchip Technology Incorporated in the U.S.A.

Analog-for-the-Digital Age, Application Maestro, CodeGuard, dsPICDEM, dsPICDEM.net, dsPICworks, dsSPEAK, ECAN, ECONOMONITOR, FanSense, In-Circuit Serial Programming, ICSP, ICEPIC, Mindi, MiWi, MPASM, MPLAB Certified logo, MPLIB, MPLINK, mTouch, PICkit, PICDEM, PICDEM.net, PICtail, PIC<sup>32</sup> logo, PowerCal, PowerInfo, PowerMate, PowerTool, REAL ICE, rfLAB, Select Mode, Total Endurance, WiperLock and ZENA are trademarks of Microchip Technology Incorporated in the U.S.A. and other countries.

SQTP is a service mark of Microchip Technology Incorporated in the U.S.A.

All other trademarks mentioned herein are property of their respective companies.

© 2008, Microchip Technology Incorporated, Printed in the U.S.A., All Rights Reserved.

 Printed on recycled paper.

**QUALITY MANAGEMENT SYSTEM**  
**CERTIFIED BY DNV**  
**== ISO/TS 16949:2002 ==**

*Microchip received ISO/TS-16949:2002 certification for its worldwide headquarters, design and wafer fabrication facilities in Chandler and Tempe, Arizona; Gresham, Oregon and design centers in California and India. The Company's quality system processes and procedures are for its PIC<sup>®</sup> MCUs and dsPIC<sup>®</sup> DSCs, KEELOQ<sup>®</sup> code hopping devices, Serial EEPROMs, microperipherals, nonvolatile memory and analog products. In addition, Microchip's quality system for the design and manufacture of development systems is ISO 9001:2000 certified.*



---

---

## WORLDWIDE SALES AND SERVICE

---

---

### AMERICAS

**Corporate Office**  
2355 West Chandler Blvd.  
Chandler, AZ 85224-6199  
Tel: 480-792-7200  
Fax: 480-792-7277  
Technical Support:  
<http://support.microchip.com>  
Web Address:  
[www.microchip.com](http://www.microchip.com)

**Atlanta**  
Duluth, GA  
Tel: 678-957-9614  
Fax: 678-957-1455

**Boston**  
Westborough, MA  
Tel: 774-760-0087  
Fax: 774-760-0088

**Chicago**  
Itasca, IL  
Tel: 630-285-0071  
Fax: 630-285-0075

**Dallas**  
Addison, TX  
Tel: 972-818-7423  
Fax: 972-818-2924

**Detroit**  
Farmington Hills, MI  
Tel: 248-538-2250  
Fax: 248-538-2260

**Kokomo**  
Kokomo, IN  
Tel: 765-864-8360  
Fax: 765-864-8387

**Los Angeles**  
Mission Viejo, CA  
Tel: 949-462-9523  
Fax: 949-462-9608

**Santa Clara**  
Santa Clara, CA  
Tel: 408-961-6444  
Fax: 408-961-6445

**Toronto**  
Mississauga, Ontario,  
Canada  
Tel: 905-673-0699  
Fax: 905-673-6509

### ASIA/PACIFIC

**Asia Pacific Office**  
Suites 3707-14, 37th Floor  
Tower 6, The Gateway  
Harbour City, Kowloon  
Hong Kong  
Tel: 852-2401-1200  
Fax: 852-2401-3431

**Australia - Sydney**  
Tel: 61-2-9868-6733  
Fax: 61-2-9868-6755

**China - Beijing**  
Tel: 86-10-8528-2100  
Fax: 86-10-8528-2104

**China - Chengdu**  
Tel: 86-28-8665-5511  
Fax: 86-28-8665-7889

**China - Hong Kong SAR**  
Tel: 852-2401-1200  
Fax: 852-2401-3431

**China - Nanjing**  
Tel: 86-25-8473-2460  
Fax: 86-25-8473-2470

**China - Qingdao**  
Tel: 86-532-8502-7355  
Fax: 86-532-8502-7205

**China - Shanghai**  
Tel: 86-21-5407-5533  
Fax: 86-21-5407-5066

**China - Shenyang**  
Tel: 86-24-2334-2829  
Fax: 86-24-2334-2393

**China - Shenzhen**  
Tel: 86-755-8203-2660  
Fax: 86-755-8203-1760

**China - Wuhan**  
Tel: 86-27-5980-5300  
Fax: 86-27-5980-5118

**China - Xiamen**  
Tel: 86-592-2388138  
Fax: 86-592-2388130

**China - Xian**  
Tel: 86-29-8833-7252  
Fax: 86-29-8833-7256

**China - Zhuhai**  
Tel: 86-756-3210040  
Fax: 86-756-3210049

### ASIA/PACIFIC

**India - Bangalore**  
Tel: 91-80-4182-8400  
Fax: 91-80-4182-8422

**India - New Delhi**  
Tel: 91-11-4160-8631  
Fax: 91-11-4160-8632

**India - Pune**  
Tel: 91-20-2566-1512  
Fax: 91-20-2566-1513

**Japan - Yokohama**  
Tel: 81-45-471- 6166  
Fax: 81-45-471-6122

**Korea - Daegu**  
Tel: 82-53-744-4301  
Fax: 82-53-744-4302

**Korea - Seoul**  
Tel: 82-2-554-7200  
Fax: 82-2-558-5932 or  
82-2-558-5934

**Malaysia - Kuala Lumpur**  
Tel: 60-3-6201-9857  
Fax: 60-3-6201-9859

**Malaysia - Penang**  
Tel: 60-4-227-8870  
Fax: 60-4-227-4068

**Philippines - Manila**  
Tel: 63-2-634-9065  
Fax: 63-2-634-9069

**Singapore**  
Tel: 65-6334-8870  
Fax: 65-6334-8850

**Taiwan - Hsin Chu**  
Tel: 886-3-572-9526  
Fax: 886-3-572-6459

**Taiwan - Kaohsiung**  
Tel: 886-7-536-4818  
Fax: 886-7-536-4803

**Taiwan - Taipei**  
Tel: 886-2-2500-6610  
Fax: 886-2-2508-0102

**Thailand - Bangkok**  
Tel: 66-2-694-1351  
Fax: 66-2-694-1350

### EUROPE

**Austria - Wels**  
Tel: 43-7242-2244-39  
Fax: 43-7242-2244-393

**Denmark - Copenhagen**  
Tel: 45-4450-2828  
Fax: 45-4485-2829

**France - Paris**  
Tel: 33-1-69-53-63-20  
Fax: 33-1-69-30-90-79

**Germany - Munich**  
Tel: 49-89-627-144-0  
Fax: 49-89-627-144-44

**Italy - Milan**  
Tel: 39-0331-742611  
Fax: 39-0331-466781

**Netherlands - Drunen**  
Tel: 31-416-690399  
Fax: 31-416-690340

**Spain - Madrid**  
Tel: 34-91-708-08-90  
Fax: 34-91-708-08-91

**UK - Wokingham**  
Tel: 44-118-921-5869  
Fax: 44-118-921-5820