

LED Driver Technologies

Planar Remote Phosphor Technology

Silicon Integrated Passive Device Technology

OLED Report

Minimising the glare and optimising the efficiency of the LED luminaries at the same time is one of the barriers for LED lighting manufacturers.

Ledlink recently launched a series of "Hybrid Optics" which combines the secondary and the reflector in one part to maximise the output but minimise the glare, and moreover it looked similar to the traditional halogen lamp.



**Hybrid Optics Series**

 **MR16- FIN Type**  
FWHM24  
 LL01CR-ACZxxL  
 CREE/XML-AWT  
 XML-EZW  
 EDISON/Federal FM White

 **MR16- PPS**  
FWHM24  
 LL01ED-ACZxxL  
 CREE/XML-AWT  
 XML-EZW  
 EDISON/Federal FM White

 **MR16- PAR 20**  
FWHM24-38-55  
 LL01CR-ABGxxL  
 CREE/MTG  
 NICHIA/283

 **MR16- PAR20**  
FWHM24-38  
 LL01ED-ABYxxL  
 CREE/MTG  
 XML-AWT/XML-EZW  
 EDISON/Federal FM White  
 NICHIA/283

 **PAR 38**  
FWHM24-38  
 LL01ED-ASAxXL  
 CITIZEN/CL233/CL330  
 CREE/CXA 2011  
 EDISON/Edipower II

 **PAR30**  
FWHM24-38  
 LL01ED-ABXxxL  
 CREE/MTG  
 XML-AWT/XML-EZW  
 EDISON/Edipower II (4W~10W)





# Lighting the Future

In mid December, 2011, the European Commission released a green paper titled "Lighting the Future". It stated that Solid State Lighting (SSL) is the most innovative technology emerging in the market for replacing inefficient lighting. However, it also mentioned that current SSL products face a number of challenges for wider market uptake: they are expensive; users are unfamiliar with this new technology and need to develop trust in its use; the technology is subject to rapid innovation; and there is a lack of standards.

State-of-the-art white LEDs have already reached 30-50% efficiency, have luminous efficacies of 100-150 lumen/Watt (lm/W) and a colour rendering index (CRI) of 80. Target values for warm white LEDs in the next 10 years are: 50-60% efficiency, more than 200 lm/W efficacy and a CRI of over 90. State-of-the-art OLED products are around 50 lm/W today. While their efficacy is expected to always stay below that of LEDs, the added value of OLED technology will come from its size, flexibility and opportunities for new applications.

In 2010, total market revenues of general lighting worldwide were around 52 billion Euros, of which close to 30% was spent in Europe. By 2020, the world market is projected to reach 88 billion Euros with Europe's share decreasing to less than 25%. Current market penetration of SSL in Europe is very low: the LED market share (in value) reached 6.2% in 2010. Several studies predict that SSL will account for more than 70% of Europe's general lighting market by 2020. But the potential for LED deployment in Europe is very large, as 75% of existing lighting installations are older than 25 years.

As LED lamps become dominant, a gradual shift of business will take place from selling replacement lamps to selling luminaires, and in particular, to selling intelligent lighting systems and lighting services. The possibility of customizing lighting characteristics to specific users' requirements will provide new business opportunities in response to the challenge of an active and healthy ageing population.

The next 3-5 years will be vital for businesses and also regions to position their strengths within the SSL market. That's why we are also looking forward to an interesting, innovative LED year - 2012.

The whole LED professional team wishes you and your family the very best for 2012!  
Thank you for your continued trust.

Yours Sincerely,



Siegfried Luger  
Publisher

**PS:**

**Don't forget:** LpS 2012, 25-27 September, 2012

Call for Papers – [www.led-professional-symposium.com/call-for-papers](http://www.led-professional-symposium.com/call-for-papers)  
(Deadline Feb 15, 2012)

# Content

■	Editorial	p 1	COMMENTARY	p 4
	Imprint	p 60	News - PROJECTS	p 6
			News - PRODUCTS	p 7
			News - RESEARCH	p 23

■	<b>EVENT</b>			
	Organic Light Emitting Diodes (OLEDs) Continue to Advance	p 26		
	by Alan R. Mills, LED professional			

■	<b>INTERVIEW</b>			
	Microcontroller Based LED Drivers Initiate New Potentials	p 30		
	Interview with Alex Zaretsky, Lighting Segment Marketing Manager, Renesas Electronics Europe GmbH			
	by Siegfried Luger & Arno Grabher-Meyer, LED professional			

■	<b>TECHNOLOGY</b>			
	Fundamentals of Planar Remote Phosphor LEDs	p 34		
	by Dr. Yosi Shani, CTO, Oree			
	Silicon Integrated Passive Device Technology for LED Applications	p 38		
	by Laurent Dubos, Market Segment Director for Lighting, IPDIAI			

■	<b>OPTICS</b>			
	Polycarbonate Leads in LED Applications	p 44		
	by Bala Ambravan, Global Product Marketing Director, SABIC			

■	<b>ELECTRONICS</b>			
	Resonant Converter Based LED Drivers	p 48		
	by Peter B. Green, LED Group Manager, International Rectifier			
	DC/DC Converters Offer Flexibility when Designing LED Drivers	p 54		
	by Steve Roberts, Technical Director of the RECOM			

■	<b>INDEX 2011</b>	p 58		
---	-------------------	------	--	--

## Advertising Index

LEDLink	C2
Recom	p 3
Cree	p 5
Sharp	p 11
Signcomplex	p 13
GZ-International	p 17
China SSL	p 23
LED professional Symposium	p 25
LED Lighting Taiwan	p 32
LED Light for You	p 53
LED professional Symposium	p 60
Instrument Systems	C3
Philips-Lumileds	C4

# LED Drivers

Buck/Boost LED Drivers - From 1W to 60W.

5 Year Warranty

Highest Efficiency

Dimming down to 0%

TRIAC Dimming

AC or DC Input



Visit us:



February 7-9, 2012 Santa Clara  
Convention Center, Santa Clara, CA  
Booth Number: 835

For Application Support contact your  
local RECOM sales contact or go to:  
[www.recom-electronic.com](http://www.recom-electronic.com)





### Pars Mukish

Pars Mukish works at Yole Développement as a Market and Technology Analyst in the fields of LED and Compound Semiconductors where he makes technical, economic and marketing analyses. He holds a Master's degree in Engineering (ITECH – France) and a Master's degree in Innovation and Technology Management (EM Lyon – France). He has worked as a Marketing Analyst and Techno-Economic Analyst for the past several years at the CEA (French Research Center).

## LED LIGHTING TRENDS IN 2012: THE RISE OF LIGHTING SOLUTIONS?

LEDs have already reached a sufficient "price/performance" level to enable massive adoption in LCD display applications. General Lighting applications will be the next and largest market for LED light sources. But the fact is that General Lighting can only take off if the cost/performance of LED based products can beat incumbent technologies. In that context, many of the lighting domain actors are developing new services in order to add innovation and value to Solid State Lighting, and differentiate them from traditional technologies. Will 2012 be the rise of Lighting Solutions?

The total General Lighting market (including lamps, ballasts, controls and fixtures) was estimated at nearly \$55B in 2010 and is expected to grow at an annual rate of 5-6% to approximately \$75B by 2015. The leading market segments are residential (41%), commercial (25%), outdoor (19%) and industrial (8%). During that period, unit shipments of incandescent, fluorescent and HID lamps should decline as a result of the better efficiency of LED lamps, global cost decrease (packaged LEDs, fixtures), standardization, growing demand for sustainable and energy saving lighting (regulations and government policies), and development of new lighting products/services.

In 2010, the market started to see major outdoor area (public and architectural) and commercial retrofit adoptions using LED modules, pushing LED penetration of General Lighting to nearly 2% of the total market. In 2011, this penetration rate has reached approximately 5% on the basis of product quality improvement and cost decrease which, combined, have enticed more and more professional customers. Total cost of ownership, remaining the main driver for most professional segments, LED lighting sources offer a real advantage toward traditional technologies: better payback. Concerning the residential segment which represents the main

trigger for LEDs massive deployment in General Lighting, penetration rate was still low due to high upfront cost of LED bulbs compared to incumbent technologies. Most people are still not willing to pay the higher upfront cost of an LED bulb even though it can last up to 50,000 hours (incandescent bulbs having an average lifetime of 1,000 hours).

If we take a look at 2012, the LED penetration rate should double and access 10% of the total market, "surfing" mainly on the increasing interest of professional customers for "cheaper technology". On the other hand, even if upfront costs decrease due to manufacturing efficiency improvements (epitaxy and packaging levels), it will not be sufficient to trigger the residential segment for which sensitive customers buy LED based products. But even if 2012 isn't the year that LEDs take off on the General Lighting market, it should be interesting because of the development of new services allowing increased functionality: Lighting Solutions.

Lighting solutions are defined as an enhancement of the lighting fixture / luminaire by attachment of external control units, providing functional lighting (through fully integrated systems). Previously, system controls consisted of a simple switch. Recently, lighting system controls integrate a number of advanced features such as enhanced RGB color changeability, dimming and color temperature control.

Most major players (Philips Lighting, Osram, and others) are tending to access (through acquisitions) this new level now that they have fully integrated the LED lighting value chain. For example, Philips Lighting proposed a portfolio of lighting solutions targeting professional segments and based on the complementarities of advisory, project and capital services.

Even if the market was still "marginal" for Lighting Solutions in 2011 due to the necessary development of adequate business models and business proposals, it could represent a strong lever of development for LEDs in General Lighting in 2012.

P.M.

## CREE XLAMP® LIGHTING-CLASS LEDs



### XLAMP ML-B & ML-E LEDs

OPTIMIZED FOR  
SMOOTH-LOOK LIGHTING

Longer lifetime than backlighting LEDs  
(and the LM-80 data to prove it)

Best color consistency with industry's  
smallest color bins



### XLAMP XM-L HVW LEDs

OPTIMIZED FOR NON-DIRECTIONAL,  
COMPACT LIGHTING

High lumen output and high efficacy  
in a small footprint

46V (Typical) - Enable smaller, cooler  
and more efficient driver circuits that  
lower system cost

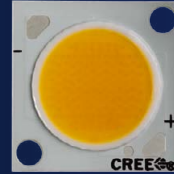

### XLAMP CXA2011 LEDs

OPTIMIZED FOR  
NON-DIRECTIONAL LIGHTING

Simple assembly—no soldering or  
connectors required

Wide lumen output range—up to  
3500 lumens at 45W, 85°C

# CREE XLAMP LEDs ARE APPLICATION OPTIMIZED FOR LOWEST SYSTEM COST

## REVOLUTIONARY!

Cree XLamp® Lighting-Class LEDs are purposefully designed to deliver the industry's best performance and optimized specifically for distinct applications.

Our revolutionary product portfolio enables you to design brighter, more efficient luminaires with fewer LEDs or simply use less LEDs and save space. So whether you're designing the next generation of indoor downlights or lights that emulate the look of fluorescent tubes, you can lower your system cost.

Get samples of Cree XLamp LEDs or contact a Cree Solutions Provider at [cree.com](http://cree.com) or call us at 800.533.2583

Get Cree reference designs for non-directional applications at [cree.com/ref](http://cree.com/ref)



# Philips Lights up Zurich's Hardbrücke, Switzerland's Largest LED Project

Royal Philips Electronics' LED lighting solutions have completely transformed Zurich's Hardbrücke, a bridge in the center of Zurich, adding life to the neighborhood while reducing energy costs.

The main lighting goal for the Hardbrücke was to upgrade the lighting under the bridge, as well as to significantly improve security for pedestrians. The lighting solution had to take bicycle and pedestrian paths into consideration as well as an additional lane for public transport and a newly laid tram line. The aim was to provide a uniform lighting experience for all bridge users.

The chosen lighting solution consists of Koffer2 fixtures on the bridge, while the 2.3 km underside is lit with 1,750 LEDline2 luminaires, making this Switzerland's largest LED project.

At the same time, the Koffer2 solution reduces Zurich's energy requirements from 32 kW to 21 kW (annual savings of 42,800 kWh), while the 1,750 LEDlines require 25 kW for 1,654 hours a year (41,000 kWh/year). Other significant benefits include reduced servicing requirements and the long lifespan of the lights.

The 40-year old bridge in the heart of Switzerland's biggest city is the main connection between the north and the south, as well as providing connections to other parts of the country. For the approximately 70,000 vehicles travelling across the bridge every day, security and functionality are of the utmost importance.

Together with the required renovation of the bridge, the municipality of Zurich chose to renew its lighting with the intention of reducing energy costs, service costs and light pollution. Additionally, Zurich wanted to shape the night view of the city and improve the quality of life for the residents. ■



LED luminaires now provide a uniform light experience for all users of the 40-year old bridge in the heart of Switzerland's biggest city

## Epistar Announces 100, 120 & 150 lm/W Warm White Chipsets

Following EPICSTAR LAB's recent 216 lm/W record-breaking achievement, Epistar introduces three LED chipset products with 100, 120, and 150 lm/W package efficiency, respectively. The three chipsets are named Standard, Premium, and Deluxe Set; all feature with CRI >85 and 2700-3000 K CCT.

Targeting the final system efficiency greater than 65 lm/W, the Standard Set emphasizes

its superior lm/\$ number and competent efficiency for 40W bulb and T8 tube replacement.

Aiming at the final system efficiency greater than 80 lm/W, the Premium Set emphasizes its impressive package efficiency with affordable cost for 60 W bulb and high performance T5 tube replacement.

Pointing towards the final system efficiency greater than 100 lm/W, the Deluxe Set emphasizes its unmatched efficiency with fair cost for 75W up bulb replacement, high performance PAR, and downlight market.

### Standard Set: 100 lm/W package efficiency

Chip Platform	Chip Type	Recommended Operation Current	Recommended Package Type
Low Voltage	V10S - blue(B) AX12 - red (R)	30mA/chip	0.27W; 27lm Three chips in one package 3528 PLCC

### Premium Set: 120 lm/W package efficiency

Chip Platform	Chip Type	Recommended Operation Current	Recommended Package Type
Low Voltage	V11A - blue AX14 - red	30mA/chip	0.26W ; 31lm Three chips in one package 3528 PLCC
High Voltage	HV45B -blue HA40 - red	20mA/chip	3W ; 360lm Four chips in one package 5050/ 6565 Ceramic 7090 PLCC

### Deluxe Set: 150 lm/W package efficiency

Chip Platform	Chip Type	Recommended Operation Current	Recommended Package Type
High Voltage	FV60 - blue HA40 -red	20mA/chip	2.7W; 405lm Four chips in one package 5050/ 6565 Ceramic 7090 PLCC



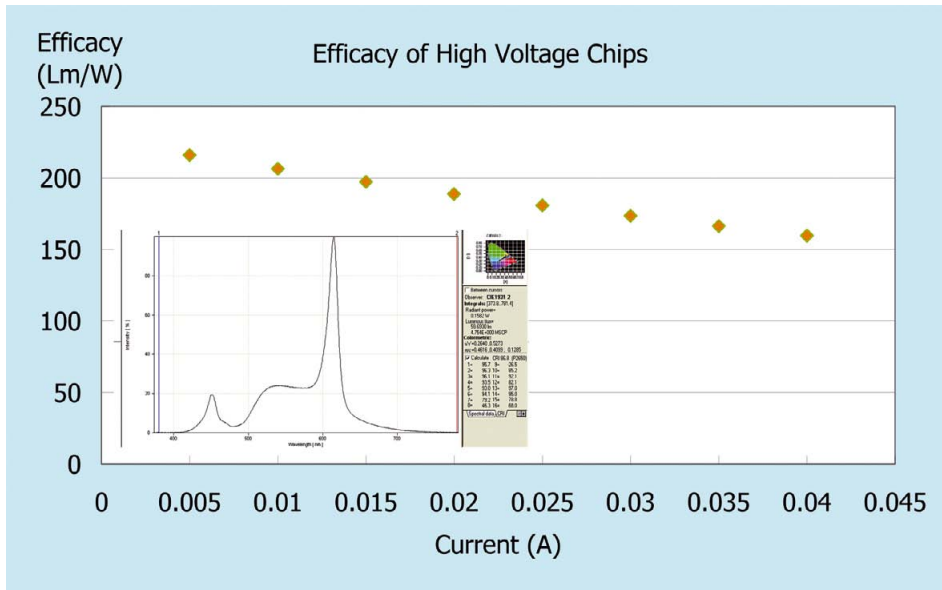

**In the EPISTAR LAB, the new warm white HV-chipset reached 197 lm/W at 1 W power consumption at 0.15mA**

#### About the Out-of-the-LAB record:

EPISTAR LAB has successfully achieved the warm white efficacy of 216 lm/W at an operating current of 5 mA and CRI of 87 Ra at CCT of 2700K. Under a typical driving current of 15mA (or about 1 W operation equivalent), the luminous efficacy of 197 lm/W was achieved.

EPISTAR LAB's new record adopts several technologies in high voltage chips, such as the novel substrate transfer process, lower MQW light absorption, fine structure for increasing the photon extraction efficiency, improvement on the current spreading uniformity, and improved MQW structure with excellent IQE and lower forward voltage. ■

## Single-Chip LED Challenges 175W MH-System

Luminus Devices, Inc., leader in Big Chip LEDs™, has announced that its next generation CBT-90 white LED is breaking new ground by providing equivalent system-level light output within specialty lighting applications, including medical and entertainment lighting, that formerly used 300W Xenon and 175W metal halide lamps.

The CBT-90, consisting of a single 3 x 3 mm chip mounted on a metal core PCB, is now 25% brighter and capable of producing more than 2,200 lm at its top end input current.

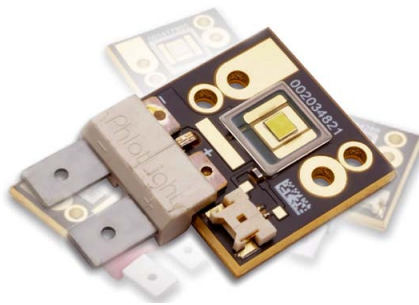

**In the CBT-90 series not only a white version but also red, green and blue versions are available**

"The new CBT-90 performance has never been achieved before by an LED," said Chuck DeMilo, Global Director of Product Marketing for the Lighting Business Group at Luminus Devices. "The lumen density and brightness of the Luminus CBT-90 are unmatched in the marketplace, and are ideal for our customers working on exceptionally demanding specialty lighting applications. For example, our customers developing endoscopy light boxes, now for the first time, have an LED that produces system-level light intensity that rivals the gold standard for endoscopy – the 300W Xenon lamp."

The story in entertainment lighting is similar as spot and wash fixtures are converting from specialty HID lamps to the CBT-90. "We expect the new generation CBT-90, featuring our industry leading Big Chip technology, will open new doors for the adoption of LEDs in some of the world's most challenging lighting applications that have been, until now, unable to reap the benefits of solid state lighting," DeMilo concluded. ■

## Sharp Expands Its Portfolio with Even Brighter LED Arrays

The new 50 W Mega Zeni models from Sharp maintain the same compact dimensions and high CRI values, yet with considerably greater luminous fluxes. These have a light output of between 3590 and 4770 lm, a luminous efficiency of up to 100 lm/W in standard operating mode and a long service life of 40,000 hours at an operating temperature of up to 90°C. They are designed for a forward voltage of 50 V and a forward current of 950 mA, but can also be operated with a standard power source of 1050mA. Other important features include: R9 values of over 85 with CRI values of over 90, MacAdam 3-step Ellipse binning, as well as good color consistency and color stability values over time under real operating conditions (hot lm).

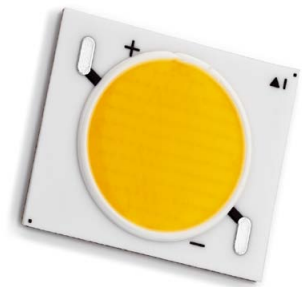

**Sharp's new 50W Mega Zeni models offer an efficacy up to 100lm/W**

The 50 W LED array launched by Sharp can thus replace traditional HID lamps in the same performance class. Compared to halogen lamps, the service life of 40,000 h of the LED array is notably longer and has a much lower decrease in brightness over time.

The slim design of the new Mega Zeni, measuring just 24 x 20 x 1.8 millimeters, together with its small LES (light emitting surface), also increases design flexibility, as it is possible to produce smaller optics and ultimately smaller lamps.

The color temperature of the new white light LED lighting components ranges from 2700 to 4000 Kelvin.

Altogether, the new 50 W Mega Zeni LED arrays are characterized by a high quality of light and high performance in a compact form. This makes them suitable for illumination of both streets and objects, as well as for indoor applications that include spot lighting and recessed ceiling light fixtures. ■

## Seoul Semiconductor Launches ZC, COB Type DC LED

Seoul Semiconductor launched its Chip-On-Board (COB) Type of Direct Current (DC) LED, named ZC (Z-Power COB). ZC series, developed based on Seoul Semiconductor's Z-Power LEDs which are mainly used as a light source of high-brightness and high-power, decreases thermal resistance, resulting in an exponential improvement in LED lighting product life expectancy. Moreover, it allows manufacturers to conveniently install and design price competitive products.

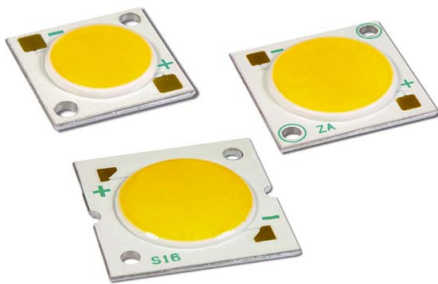

**SSC's ZC-series will be offered in 6W, 10W and 16W to challenge 40W, 60W and 100W incandescent bulbs and downlights**

The ZC Series is designed as a COB type and removes the need for the LED to be surface-mounted on to a metal plate, allowing manufacturers to bypass the chip connection process before use. Companies can trim manufacturing and management costs and greatly improve end product price competitiveness.

Furthermore the use of highly-reflective aluminum substrates in ZC also greatly improves the brightness and significantly prolongs LED bulb life spans. It is possible to use a single ZC from the ZC series to develop a LED light bulb which then allows light to be distributed more evenly than lights that connect several LED packages to a single module.

SSC's ZC-series will be offered in 6 W, 10 W and 16 W, each of which will be appropriate replacements for 40 W, 60 W incandescent light bulbs and 100 W down lights.

"The ZC will enable manufacturers to easily produce various LED light designs and providing longer-lasting LED lights," explained Sunghoon Bae, Vice President of Seoul Semiconductor. ■

## Lustrous Launched New LED Platform,

Lustrous Technology has introduced new high efficacy LED product, N506, with cool white (5000 K) LEDs, CRI 70, produces 140 lm/W, while warm white (3000 K) LEDs, CRI 90, efficacious by producing 125 lm/W.



**Lustrous N506 delivers a white light efficacy of 140 lm/W@CRI 70, and a warm white light efficacy of 125 lm/W @ CRI 90 at an operating current of 200mA, Vf=30V, 6W**

With multiple patents on COB (Chip-On-Board) technology, Lustrous (4997TW) offers excellent lighting solutions in the LED industry. This new item, N506 features significant efficacy of photoelectrical and more flexibility on LED applications in design.

Followed by Lustrous professional COB packaging technology, N506 brings out outstanding levels of advantages, provides higher LED lamp efficacy as well as better lighting output. In addition, by applying N506, the creativity of lamp design can be more diverse. Furthermore, N506 has proven itself with better thermal dissipation issues.

N506 performs as much lumen output as a 60 W incandescent lamp, but merely consumes 6-8 watts of power. ■

## Osram OS's Oslon Square Makes Even Better Use of Light

Osram OS's new Oslon Square opens up a wide range of possible uses, including designer luminaires for the home or office, retrofits and street lights.

This new LED has all the right credentials for widespread use – it is small, powerful and capable of operating on different currents, and therefore can be used for manufacturing different products for different target markets.



**The reflective package of Oslon Square even makes use of the light emitted at the side between the chip and the lens**

Like the Oslon SSL, the Square measures only 3 x 3 mm, has a low thermal resistance of 4 to 3.8 K/W and is accommodated in a robust package which is suitable for outdoor use. The LED chip is enclosed by a reflective package that reflects light emitted at the side or at the back so that this light is usable. Light that is reflected back to the LED within a system – for example from a diffuser – can also be used in this way.

**The LED is available in many different versions with different color temperatures:** The Oslon Square EC is suitable for indoor applications in which a high quality of light is needed, for example, in offices, but also for retrofits. With a color temperature of 3000 K it provides a warm white light and also offers high color stability over a wide viewing angle (120°). The CRI is at least 80. If the lighting needs to be particularly uniform a "fine-bin" order can be placed for this LED. At an operating current of 700 mA it achieves an efficiency of above 90 lm/W and a luminous flux of 200 lm and more. At 350 mA its efficiency passes 100 lm/W.

The Oslon Square PC and UW are designed for outdoor applications, for example in street lighting. They can be operated on currents of 200 mA to 1.5 A. The LEDs produce a neutral white to cold white light with color temperatures of 4000 K and 6000 K. And at 130 lm/W from 350 mA they are even more efficient than the warm white version. With a CRI of at least 70 (4000 K) and 65 (6000 K) these LEDs combine good quality of light with high efficiency.

Ivo Ivanovski, Product Manager for the Oslon Square series, summarized the benefits of the new LED as follows: "Every application places different demands on lighting, and with the Oslon Square we are providing a platform for tailor-made solutions." ■

## Osram Extends PrevaLED Series with the 70% More Efficient Core Eco Z2 Line

Osram now offers an up to 70% more efficient generation of the PrevaLED LED Light Engine range. The PrevaLED Core Eco Z2 line attains a module efficiency of up to 108 lm/W. The standardized basic information, such as dimensions, luminous flux and light distribution, is the equivalent to the Edison socket in the analogue world of light.



**Osram's new PrevaLED Core Eco Z2 Line adds to the huge portfolio ranging between 800 lm and 5,000 lm**

Technical Data:	
Diameter of module	50 mm
Color temperature	2,700K, 3,000K, 3,500K, 4,000K
Color rendering	Ra > 80
Luminous flux	800 lm, 1,500 lm, 2,000 lm, 3,000 lm [additional varieties in 4,000 lm and 5,000 lm available from spring 2012]
Service life	Up to 50,000 hours
Module efficiency	Up to 108 lm/W (at operating temperature)
System efficiency (Module, cable and driver)	Up to 94 lm/W (at operating temperature)

PrevaLED Core Eco Z2 can replace high pressure discharge lamps of up to 70 W, energy saving lamps with up to 2 x 42 W and halogen lamps, each with up to 100 W power consumption, and therefore the traditional technologies in the majority of the spotlight and downlight applications. Prerequisite for this, however, is the large portfolio ranging between 800 lm and 5,000 lm. Owing to LED technology, the light does not contain any harmful UV or infrared light components. ■

## GE's New Tetra® LED Lighting Systems for Channel Letters

GE Lighting Solutions, LLC has released the next generation of Tetra® LED lighting systems for channel letters. These new products provide outstanding uniformity and use fewer modules than previous models.



**The new Tetra® LED lighting systems for channel letters provide excellent uniformity and use less modules than earlier models**

GE's enhanced Tetra LED lighting systems include:

Tetra miniMAX - for small channel letters 1.5 inches in depth or greater, with 81 lm/W, the new products efficacy is 43% greater than the previous Tetra miniMAX, uses 26 percent less energy and, with 9 inches, has 80% wider stroke spacing in a 4-inch sign. Also power supply loading is increased by 50 percent, from 40 feet to 60 feet.

Tetra MAX and Tetra MAX High Output - for medium channel letters 4 inches deep and up to 36 inches high. The new Tetra MAX is 25% brighter (75 lm/foot) and its efficacy is 33 percent greater (59 lm/W) than previous generations. Tetra MAX High Output is 92% brighter at 115 lumens per foot with 36% greater efficacy, and uses the same layout rules as the new Tetra MAX. With 9 inches, stroke spacing for both is also improved by 80% in a 5-inch deep sign.

Tetra PowerMAX - for large channel letters up to 4 inches deep and 36 inches or taller, Tetra PowerMAX increases brightness by 25% over its predecessor (182 lm/foot) and decreases costs by increasing stroke spacing by 50 percent in a 4-inch deep sign to 9 inches.

The next-generation Tetra LED lighting systems feature GE's patented technology OptiLens™ that maximizes LED performance by capturing otherwise wasted light and redirecting it toward the illuminated surface to create an exceptionally uniform channel letter. This unique lens technology allows wider stroke spacing, which helps reduce the amount of material needed in each sign. ■

## Vexica Technology Announces New 2000lm LED Module

The new Lumaera OEM LED module offers manufacturers unparalleled ease of integration of LED technology. Offered in 1200 and 2000 lumen packages, this new LED module has an interface for a twist and clip AR111 form factor reflector allowing easy selection and changes of optical distribution patterns without the need for specialist tools. It includes a TRIAC dimmable LED driver and a dedicated heat sink is available, too. This allows the OEM manufacturers to offer clients considerable savings on both energy and maintenance with a cost effective luminaire solution.



**The Vexica LUMAERA LED module system gives OEM manufacturers versatile LED solutions without the associated research and development costs**

The Lumaera module has the following key features:

- On-board TRIAC mains dimming driver
- 95 mm diameter OEM heat sink
- Optional silent active heat-sink cooling
- 111 mm twist and clip on reflector
- Remote Phosphor color conversion for high CRI options
- 1200 and 2000 Lumen options (high versions due Q2 2012)

Unrivalled light output is achieved using the latest LED technology and Vexica's highly efficient TRIAC dimming integrated driver. High CRI options are available providing rendering indexes over 90 achieved via Vexica's proprietary mixing chamber and Intematix remote phosphor technologies.

Vexica have integrated the very latest CREE XT-E LEDs specifically tuned for use with remote phosphor systems. White diffuser LED versions are also available using a range of high power LEDs where customers demand a more cost sensitive version but still want high levels of efficiency. We are able to incorporate your LED of choice if you have an affinity or preference for a certain brand. ■

## Xicato Introduces 3000 lm and 4000 lm XLM LED Modules and Adds 3500 K Modules

Xicato extends its range of LED modules by the XLM LED module series with a lumen output that allows replacement of high wattage halogen lamps. In addition Xicato announced the extension of the available CCTs for its modules with a 3500 K version for modules with above 1000 lm.



**Xicato now offers most of its modules, including the new XLM series, with a CCT of 3500 K, an increasingly popular CCT in the USA**

### Xicato XLM Series:

Recognized by the IESNA's recent 2011 Progress Report, Xicato's new 3000 lm and 4000 lm XLM LED modules provide light levels that replace inefficient high wattage halogen and metal halide lamps which have color stability and controllability issues.

At up to 80 lumens per watt, the XLM family provides a completely controllable source. Offered in 3000 K, 3500 K and 4000 K, the Xicato XLM is a high light quality, energy efficient and low maintenance solution.

As with all Xicato LED modules, the XLM range has a rugged glass and aluminum architecture, 1x2 SDCM color consistency and industry leading lumen and color maintenance.

### Xicato's 3500 K Modules:

Xicato introduces a 3500 K Correlated Color Temperature (CCT) option to its range of LED modules. 3500 K is the predominant color temperature for ambient lighting in North America.

The new color will be offered in all Xicato flux packages starting at 1000 lumens and above, including the 1000 lm Artist Series Xicato Spot Module, which offers halogen-like color rendering properties with a CRI, 95+ and a typical R9 of 96, is also available in 3500K. ■

## Cree LMH2 LED Modules Offer Unrivalled Efficacy and Light Quality

Cree, Inc. announces the commercial availability of the new LMH2 LED module family, designed to speed time-to-market for high-quality LED luminaires. The barrier-breaking LMH2 is the only LED module delivering 80-lumens-per-watt system efficacy combined with CRI greater than 90. The modules feature Cree TrueWhite® Technology.

The compact, two-piece module allows maximum design flexibility. By separating the light source and power supply, Cree gives luminaire designers a broad range of options for mounting, wiring and reflector design.

The LMH2 is available at 850 and 1250 lumens and in color temperatures of 2700 K, 3000 K, 3500 K and 4000 K. Designed for 50,000 hours of operation and dimmable to five percent, the LMH2 comes with Cree's new industry-leading five-and-a-half year warranty.

The LMH2 is also UL-recognized and complies with multiple international regulatory and safety standards. Fixture makers seeking ENERGY STAR® qualification will have access to specification and performance data, including LM-80 reports, which can speed regulatory approvals. ■

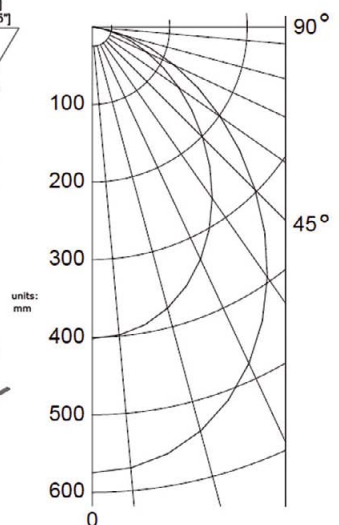
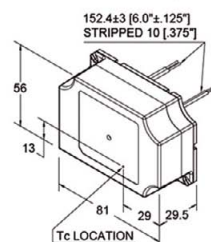
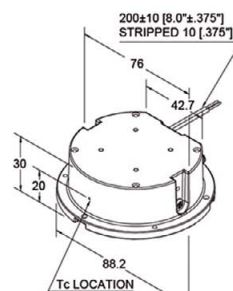

**Cree's new LMH2 is a simple to apply LED module delivering 80 lm/W system efficacy combined with a CRI greater than 90**

## Philips Second Generation Fortimo LED Spotlight Modules

The second generation Fortimo SLM offers performance upgrades of up to 100 lm/W of the modules, improved color consistency, and is also more energy efficient. These upgrades will help to make retail environments look even brighter, more vivid and attractive.



**Philips's Fortimo LED spotlight module (SLM) Gen 2 includes performance upgrades that provide high quality white light and excellent beam homogeneity for retail applications**

The upgraded Fortimo SLM modules will offer the following advancements:

- High CRI up to 95 combined with tight color consistency
- Excellent lumen maintenance of 70% at 50 khrs at 75°C
- System efficiency resulting up to 90 lm/W

# HIGH COLOUR RENDERING INDEX

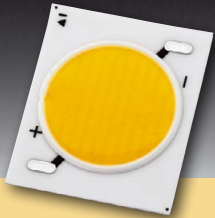

[IC]

[OPTO]

[LED]

[LCD]

[RF]

Sharp has extended its LED portfolio to include three high-luminosity modules: the 15W, 25W and 50W MegaZENI LEDs. These LED arrays are compact, light and extremely bright with a shinningly high light quality. Sharp's MegaZENI LEDs give product developers and designers the chance to achieve the best possible colour reproduction in surroundings where ultra-high luminance is essential, e.g. spotlights or downlights. These new arrays stand out from the crowd with a luminous flux of up to 4,770 lm, a luminous efficacy of up to 105 lm/W, a CRI of up to 93 and a lifetime of up to 40,000 hours at an operating

temperature of up to 90° C. Such qualities mean they are not just the intelligent alternative to individual LEDs but also first choice for indoor and outdoor lighting applications. MegaZENI LEDs are Energy Star and ANSI-compliant, combine maximum energy efficiency with minimum thermal dissipation, and come in various colour temperatures from warm to cool white.

**Our Service Team will be glad to supply you with any engineering samples and advice you need. E-Mail: [info.sme@sharp.eu](mailto:info.sme@sharp.eu); Phone: +49 (0)180 507 35 07; [www.sharpleds.eu](http://www.sharpleds.eu)**

light+building

Visit us at the Light+Building 2012  
from 15–20 April in Frankfurt am Main: Hall 4.2, Booth J71.

**SHARP**

| Microelectronics

This new generation also makes design-in even easier with the use of the specular reflectors to create excellent beam homogeneity with an innovative silicone dome.

The central promise of the Philips Fortimo LED product range is constant innovation within a fixed format and includes a standardized optical interface and standardized lumen packages. This also applies to the new generation of Fortimo LED spot light modules. The new Fortimo LED SLM guarantees fixed lumen output and light distribution, is compliant with upcoming industry standards when it comes to standardized optical, mechanical, electrical and thermal interface, and is backwards compatible with the previous SLM generation.

In expanding the portfolio, the second generation Fortimo SLM also includes an additional module range with a color temperature of 2700 K, which can be applied to various retail application areas to create new atmospheres and scenes. ■

## Relume Launches First High Wattage LED Retrofit Product

Relume Technologies, a leading manufacturer of LED products and smart grid control systems for outdoor lighting applications, has announced the launch of Illumadisk™, the first high wattage LED retrofit product.



**Illumadisk™ is the solution for up to 250 watts high pressure sodium or metal halide high intensity discharge (HID) products retrofitting**

Illumadisk is part of Relume's retrofit streetlight product offerings and is used to retrofit high wattage decorative teardrop fixtures that light main streets, municipalities and parking lots. This retrofit kit produces light levels comparable to 250 W luminaries, however the technology only requires 80 W.

"Cities are now able to retrofit their high wattage decorative fixtures, a portion of the outdoor lighting market that was previously not a candidate for LED retrofits" explains Crawford Lipsey, CEO for Relume.

Illumadisk™ features Relume's superior thermal management and low LED junction temperatures – key to long LED life and enables Relume to offer a seven year product warranty. In addition, the LED light engine is protected by a high-impact, UV stabilized, non-yellowing lens.

Relume's plug and play retrofit products fit most post top fixtures, allowing cities to upgrade to high performing LED light engines in minutes, while retaining the relatively costly existing fixture. The new light engines will lower energy consumption by as much as 40 percent and last up to six times longer. The substantial savings in reduced energy and maintenance costs results in an average payback on investment of less than four years. ■

## Vision Engineering Delivers Unparalleled Uniformity for LED Solutions

Vision Engineering announced that its patented coining technology is available to lighting OEMs that endeavor to bring the most uniform lighting solutions to market at costs that make rapid adoption possible. Vision Engineering's technology can be implemented in lighting solutions for the commercial, industrial, residential, and entertainment segments.



**Vision Engineering's LUXEON based solutions use a unique coining process to deliver the most uniform lighting solutions**

Coining, or cold forming, is a well-known process in the forging industry where 3 dimensional shapes can be formed to

exacting tolerances. Vision Engineering has developed this technology and applied it to lighting. Using their technology, multiple geometric surfaces can be created to control the distribution of the light resulting in extremely uniform solutions.

"We're making it easier and more affordable for LED solution developers to get the light where they want it, need it, without trying to staff with optical engineers and designers," said Henry Avila, CEO of Vision Engineering. "We match our unique optical design capabilities with LUXEON LEDs to deliver the highest quality results."

Vision Engineering has implemented its technology in a new line of Troffers for office lighting and its customers are delivering solutions for refrigeration, transparent LCD's displays, High Bay lighting. ■

## 16east LED Light's LED Bulbs with the Brilliance of an Incandescent Lamp

Seitz Smart Technologies with the brand 16east LED Light brings a new LED bulb with clear glass and the pleasant light of an incandescent bulb and a consumption of 7 watts/450 lumens, which is equivalent to a 40 watt light bulb. It is the latest product from the 16east LED Light research department. The clear 16east LED bulb as an equivalent for 60 watt bulbs shall follow in the first quarter of 2012. The development of a 100 W equivalent is in progress. The 16east Retrofit LED lamps stem from an in-house development which is being promoted by the FFG (Austrian Research Promotion Agency).

### Brilliant light:

The small, bright ball of light and the optics of the clear 16east LED bulbs and candles enable brilliant light similar to that of a small, bright filament of a classic light bulb. As a result, they are also suitable for application in crystal chandeliers, where they generate the brilliance and "fire" of crystals and make surfaces glisten.

Due to the small scattering ball of light inside the clear bulb, the 16east LED lamp generates a brilliant light that is not possible through LED lamps with a matt surface.

We bring innovation and give impression ■  
Technology and Green ■■



Tel: +86 755 2760 8650 Fax: +86 755 2760 8651 www.signcomplex.com info@signcomplex.com



Two highlights out of the broad 16east product range are the fully dimmable 40W equivalent brilliant clear E27 bulb (left) and the 60 W equivalent LED bulb

**Patented optics and full dimmability:**

The patent ball of light provides a pleasant, warm light and illumination as it is known from a light bulb and good light distribution with 300° all-round radiation.

“The development of optics was the greatest challenge for us. As a result, we are able to offer bright LED candles and bulbs with pleasant light color and all-round radiation”, says Stephan Seitz. ■

## Verbatim Announces Family of Retrofit LED Lamps for Homes

Verbatim has announced a family of LED lamps designed for domestic applications. Described as the consumer range, it comprises two E27 Classic A lamps, two MR16s with GU5.3 fittings and a PAR16 with a GU10 socket.

With the exception of the 12 V AC/DC MR16 versions, the new lamps operate from 220-240 VAC. All offer warm white light with color temperatures between 2500 K and 2800 K and operating lifetimes of 25,000 or 35,000 hours, depending on the model.

E27 and MR16 3 W versions are dimmable, while CTA (Color Temperature Adjustment) technology which mimics incandescent lights in producing a warmer tone when dimmed is a key feature of the 6.5 W E27 Classic A-Lamp.

The E27 Classic A lamps, available with 6.5 W or 9 W, are designed as replacements for 20 or 40 W incandescent lamps, producing 190 and 440 lumens output respectively with a color rendering index (CRI) of at least 75 for the 6.5 W lamp and 85 for the 9 W model.



**Verbatim's new lamps are designed as economical alternatives to Verbatim's professional product range and all are available through wholesalers and electrical retailers**

The MR16s come in 3 W and 6 W types with beam angles of 30 degrees and 25 degrees and a typical CRI of 80 and luminous flux of 110 or 225 lumens respectively. The 4 W PAR16 has a 28-degree beam angle and delivers 100 lumens with a luminous intensity of 380 cd and CRI of typically 75. ■

## Amerlux Launches Replacements for MR16 Halogens

Engineered to replace Halogen MR16 track heads with high performance levels, Amerlux launches the Hornet LED family of low voltage high performance track luminaires. The new 15-watt LED Hornet is a true replacement for a 50-watt MR16 halogen fixture in lumen output and center beam candlepower (CBCT), with the capability to replace track heads currently being used on existing low voltage track systems.



**Amerlux's Hornet luminaire can be mounted on low voltage track systems or canopies**

Designed with an inconspicuous, miniature size, the Hornet LED luminaires are precision engineered for optimal thermal and optical performance. A state-of-the-art 15-watt LED (developed after one year of research by Philips Lumileds) provides light output equivalent to 50-watt halogen lamp while using one-third the power. Life at 70% of initial lumen output is rated at 50,000 hours, which is more than 10-15 times longer than halogen providing for lower operating and maintenance costs with a great energy savings.

With full range dimmability and specialized optics, the Hornet can be adapted to a 15-degree Spot, that delivers 800 lm, a 28-degree Flood with 785 lm, or a 45-degree Wide Flood that delivers 775 lm.

Amerlux uses microbinned LEDs to maintain color quality and consistency from fixture to fixture. Hornet deploys a crisp white light at a 3000 K constant color temperature and a CRI of 82 that delivers clean consistent beams free of UV/IR radiation, making it optimal for lighting color or heat sensitive merchandise.

Hornet is backed by an unprecedented 10-year warranty. Hornet is CSA listed. LM79 and LM80 reports are available, as well as IES reports. ■

## Energy Savings and Color Fidelity – The New C8-Series LED by Lumitech

The leading Austrian high-tech company Lumitech® is once again a step ahead of the competition in LED innovations. True to the company's mission, the C8 downlight series offers the optimum mix of efficiency, environmental friendliness and light quality.



**Lumitech's high energy efficiency and excellent color rendering C series are combined in the LED Downlight with an integrated converter**

### Main advantages:

- Superlative color quality: CRI 90 - long useful life: up to 50,000 h
- Easy replacement of and compatibility with existing sockets

### Technical data:

- Low energy use: 11 W (230 VAC)
- Light colors: 2,700 K; 3,000 K; 4,000 K
- Dimming function: 20–100 % (trailing edge dimmer)

The C8 downlights provide attractive energy savings of 85% compared with traditional lighting elements combined with a long useful life of up to 50,000 hours. In addition to excellent light quality, the series also offers its users advanced dimming functionality and simple, tool-free replacement of halogen spots.

## Zenaro Announces Modular LED Replacement for FL Troffer Systems

LED lighting specialist Zenaro's OL-Deluxe series is a new energy-efficient solution for planners based on the company's LED tube light modules.

Using the directionality of LED light sources to attain high luminaire efficiency in combination with specular louvers to provide visual cut-off of the light source, the all new recessed luminaires offer significant energy savings while delivering high quality, glare free illumination.

Each luminaire in the OL series provides instant-on switching with zero flicker and a 140° beam angle distribution.



**Zenaro presents new louver luminaires with T5 LED tubes**



The square QL2 luminaire delivers target illumination equivalent to typical 3 lamp 18 W T5 luminaire when spaced in 8 foot centers, consuming 44 W at a system efficacy of 75 lm/W, delivering 2900 lm in four color temperatures ranging from 3000 K to 6000 K CCT. The replaceable tube light modules provide a service life >35,000 hrs L70. The long QL4 luminaire delivers 5800 lm >at 80 lm/W consuming 88 W, while the slim BL4 produces 2900 lm at 44 W, completing the line with the most popular commercial recessed modules.

They are constructed from high reflectance white coated steel, with specular clear anodized louvers. A stiff frame surrounds the luminaire opening for secure installation in grid ceilings, or installation in hard ceilings with perimeter flange. Each luminaire includes its own 48 VDC power supply to produce optimum efficiency and greatest safety. The LED tubular modules are mounted via standard T5 style sockets, and are easily replaced at the end of service life in the same manner as conventional fluorescent lamps.

The OL-Deluxe line is an efficient and attractive solution that delivers comfort and efficiency in a familiar package, well suited for commercial offices, health care facilities, school, production and retail facilities.

LED lighting produces the greatest savings and operational cost reductions in spaces where lighting is operated for long periods of time, such as corridors, factory spaces, and retail environments. Energy savings from 15% to 25% over typical T8 or T5 fluorescent systems, combined with long service life and strong illuminance performance makes the OL-Deluxe series an attractive choice. ■

## LEDiL Introduces Three New High Quality LED Optics Series

LEDiL expands its popular precision-engineered STRADA Series to include the new STRADA-F Series lens family. Furthermore LEDiL introduces the precision-molded MR11 (32.4mm and 35mm diameter versions) MINNIE reflector series and JULIA-A lenses to its already extensive range of precision-engineered rotationally symmetrical lens.

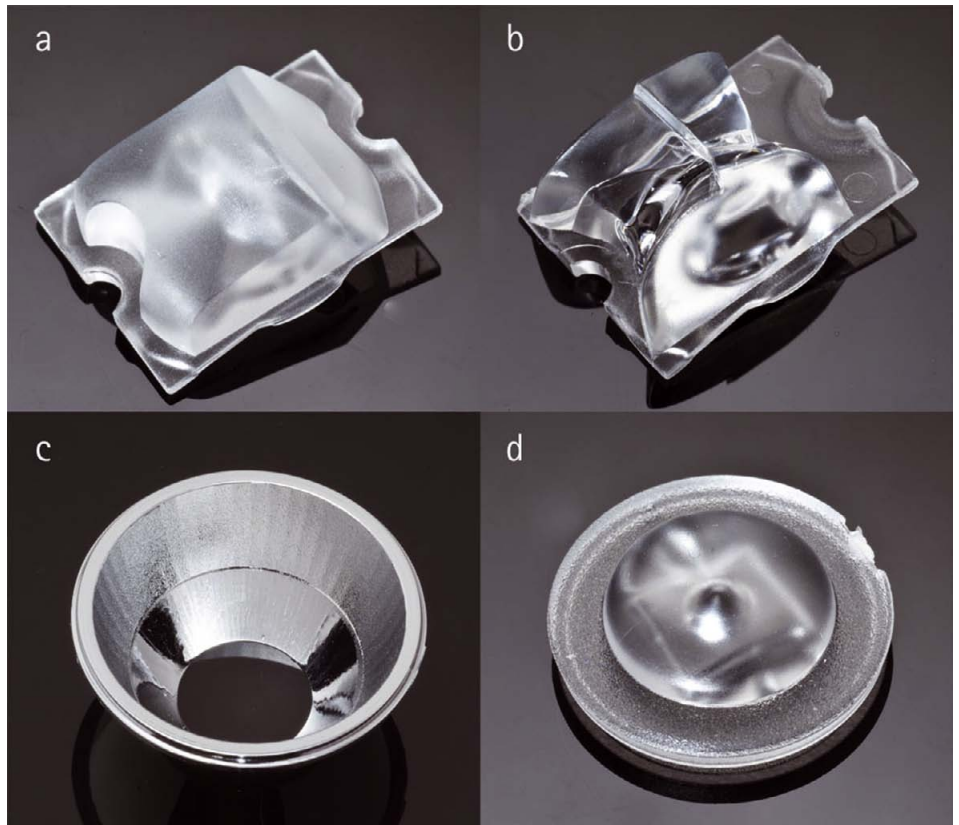

**LEDiL recently expanded its line of LED optics with (a) the STRADA-FT, (b) the STRADA-FW, (c) the MINNIE-M reflector and (d) the JULIA-A lens series**

### STRADA-F Series:

STRADA-F Series are compact lenses, 15.4 mm wide x 19.6 mm long, molded from UV-stabilized optical-grade PMMA plastic, boasting over 90% transmission efficiency. STRADA-FT, 8.2 mm high, directs light in a forward peak of 55 degrees. The slightly taller (10.8 mm) STRADA-FW offers a wider emitting pattern in a forward peak of 55°.

STRADA-F Series is optimized for peak performance with LEDs from Cree, Philips Lumileds, Osram, Nichia and others.

With the addition of STRADA-F Series, LEDiL's STRADA family of products – 10 different styles offered in various symmetrical and asymmetrical light distribution patterns - can be combined in a single fixture to allow manufacturers of wide-area light fixtures to design efficient and compact products that meet IESNA standards.

### MINNIE Reflector Series:

LEDiL's precision-molded MR11 (32.4 mm and 35 mm diameter versions) MINNIE reflector series allows for rapid deployment of new lighting solutions using Cree MT-G LEDs. Lighting designers now have a more reliable, low-cost choice than metallic reflectors.

Molded from durable polycarbonate plastic resin, the reflectors, currently available in 26, 36 and 74 degree FWHM (full width half modulation) beam patterns, are finished in an aluminum coating with a protective lacquer finish and provide greater than 90% optical efficiency.

### JULIA-A Rotationally Symmetrical Lenses:

JULIA-A is a rotationally symmetrical lens that produces batwing light emission pattern, which allows LEDs such as Cree's XP Series or Philips Lumileds' Rebel and Rebel-ES Series, to achieve over 90% uniformity on display surfaces 50 – 100 mm from the PCB. Since these and other similar LEDs are inherently point-sources of light, JULIA-A lenses enable the LEDs to be used in a wide-variety of backlighting applications.

The lens is less than 19 mm in diameter and only 4.66 mm tall (4.81 mm with optional tape). Precise mounting is ensured by the addition of two 0.63 mm mounting pins and the product is available with optional automotive-grade polyurethane foam mounting tape for easy and reliable installation. LEDiL molds JULIA-A from optical-grade, UV-stabilized PMMA plastic. ■

## ZMDI Launches Highly Efficient Boost Converter for Low Voltage HB-LEDs

ZMD AG is introducing ZLED7015, its first step-up converter with integrated 35 V power switch for high brightness LEDs. It is optimal for driving multiple white LEDs connected in series from a low voltage supply.

The ZLED7015 can also drive devices that require a constant voltage. The wide input voltage range of 6 V to 30 V supports applications with input voltage from multi-cell batteries or regulated 12 V and 24 V power rails. A low voltage feedback mechanism helps maximize the operating efficiency. The device's soft-start function and open circuit detection protects the application circuit and extends the LED life.

### Main Features and Specifications:

- Wide input range of 6 VDC to 30 VDC
- Fast 1.0 MHz switching frequency
- Open and short circuit detection protects against high currents
- High efficiency of up to 95%
- Small form-factor package
- Ideal for low voltage retrofit lighting

The ZLED7015 operates with a switching frequency up to 1 MHz allowing the use of smaller, less expensive external components. A low 0.3 V feedback voltage minimizes power loss in the current setting resistor for better efficiency.

With an adjustable over voltage protection, the chip and the system operates safely even if the load is not connected or the output is short circuited.

A built-in soft start circuit significantly reduces the inrush current during start-up and extends the LED's lifetime. Further features include under voltage protection as well as over temperature protection. ■

## IR's IRS2500 $\mu$ PFC™ Control IC Reduces Noise Sensitivity

International Rectifier, IR® announced the introduction of the IRS2500  $\mu$ PFC™ power factor correction (PFC) control IC for switch mode power supply (SMPS), LED drivers, fluorescent and HID electronic ballast applications.

The IRS2500  $\mu$ PFC controller can be configured to operate in critical conduction boost PFC or flyback configuration. The new device also features a total harmonic distortion (THD) optimization circuit to reduce line current harmonics. The controller has high noise immunity, simplifying design and reducing system cost.

"The IRS2500  $\mu$ PFC reduces noise sensitivity, eases PCB layout and provides a cost-effective alternative to existing solutions," said Peter Green, LED Group Manager, IR's Energy Saving Products Business Unit. ■

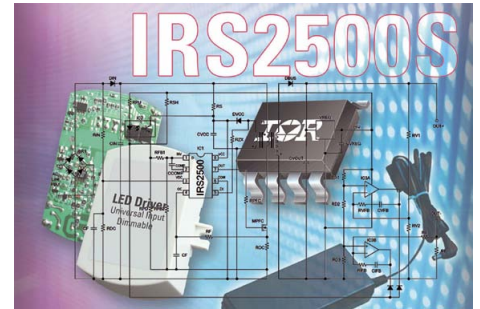

IR's new IRS2500S  $\mu$ PFC controller allows designs of electronics for different lighting technologies, such as LED lighting

Available in an SO-8 package, the IRS2500 also features micro power start up current of less than 50  $\mu$ A, quiescent current of 2.5 mA, drive capability of +800 mA/ -600 mA as well as static and dynamic over-voltage protection and over-current protection. The short minimum on time of the device allows wide input range power factor correction for universal input operation.

## Power Integrations' LinkSwitch™-PH in a Low-Profile Package

Power Integrations announced the availability of LinkSwitch-PH LED driver ICs in a low-profile eSIP™-L package that is just 2 mm high.

The new package targets applications where board height is constrained like replacements for fluorescent tubes, where very low-profile packages are required to fit into the small space available behind the LED circuit board.

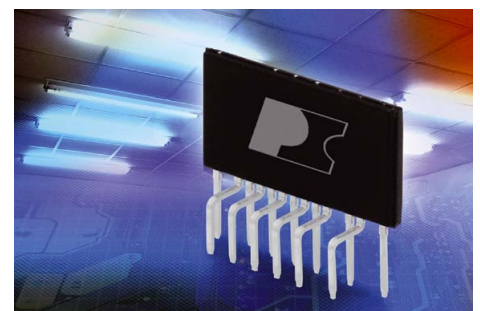

PI's new 2-mm package permits placement of driver board behind the LED PCB, enabling illumination along entire length of lighting tubes

LinkSwitch-PH devices in the 2-mm eSIP-L package have the same thermal and electrical performance as previously released ICs in the eSIP-E package. Due to the electrically quiet (source potential) heat transfer tab on top of the device so any additional heatsink does not contribute to electrical noise propagation. ■

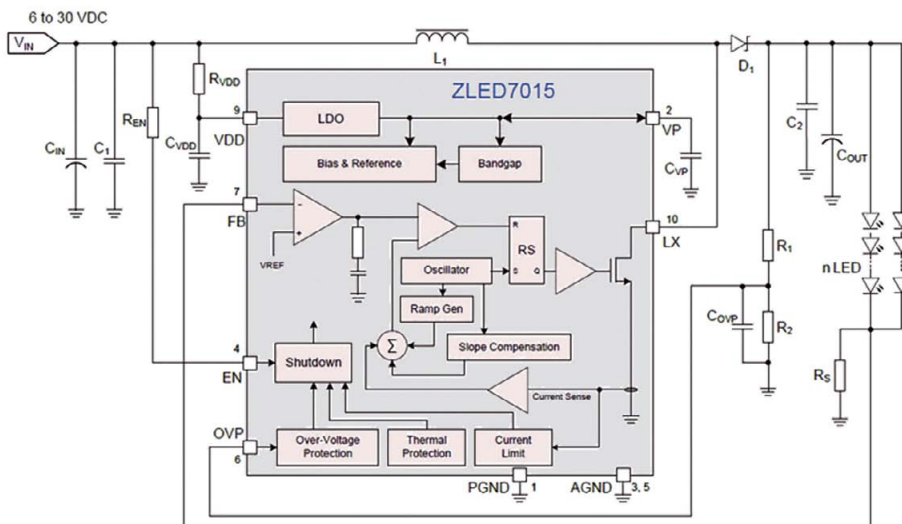

ZLED7015 typical application circuit and IC block diagram

# guangzhou international lighting exhibition

# 17<sup>th</sup>

## 9 – 12 June 2012

China Import and Export Fair Complex  
Guangzhou, China

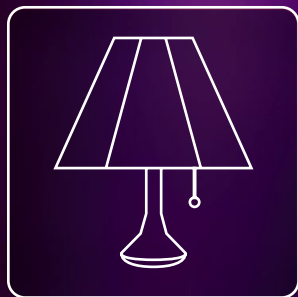
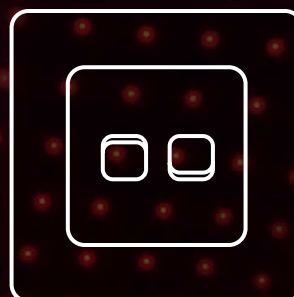
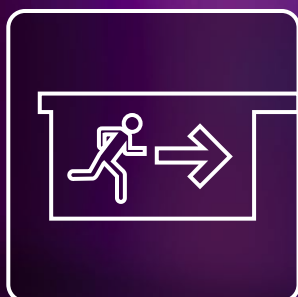

### Show highlights:

- The most influential and comprehensive lighting and LED industry event
- 6 theme zones covering full spectrum of lighting products and LED technologies
- Over 200,000 sqm spanning 21 halls, featuring more than 2,700 exhibitors in 2012
- 2011 show attracted 100,465 visitors from 116 countries and regions

For more information, please contact  
Tel: (852) 2802 7728 Fax: (852) 2598 8771  
Email: LBguangzhou@hongkong.messefrankfurt.com  
www.light.messefrankfurt.com.cn



messe frankfurt

## ELMOS: Efficient High-Voltage LED Controller Family

With the E522.3x chips, ELMOS introduces a new LED controller family. The ICs are designed for input voltages between 5 V and 55 V and an output voltage of up to 60 V in boost mode, and they can be operated – depending on the type – in single and/or dual LED chain mode.

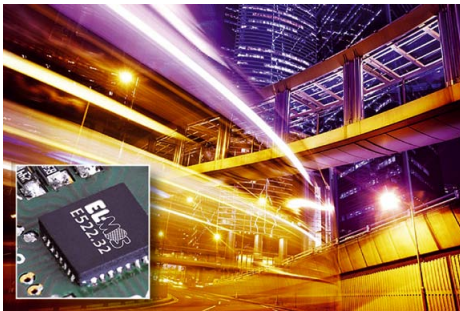

**ELMOS E522.3x ICs are made especially for use in harsh environments with an ambient temperature range of -40 to +125°C**

In addition to high robustness, the ICs offer a great variety in the selection of circuit topologies, such as boost, SEPIC, buck-boost, and buck. The switching frequency can be adjusted to up to 600 kHz and can be synchronized with other components in master-slave configuration. Power consumption in sleep mode is only 8µA.

The versatility of the E522.3x controller family is completed by various control and monitoring functions, e.g. protection against short-circuit, over-temperature, overvoltage and undervoltage, and load break.

This IC family is supplied in the shape of single or dual controller in a QFN32L5 package. ■

## ETC's Tiny Tessera™ Touchscreen Controls Complex Effects

ETC named its new touchscreen lighting-control product after the ancient word for 'tile.' As ETC's Architectural Market Manager Joe Bokelman explains, "A tessera is a tile in a greater mosaic but also an object of beauty and utility itself. Our Tessera is both a part of a greater sophisticated networked system and a compact standalone full controller."



**The versatile Tessera, or Unison Mosaic Tessera™ Controller (MTPC)**

A sleek new addition to ETC's Unison® line of architectural control, Tessera combines a 4.3" touchscreen with a 512-channel DMX-Over-Ethernet Mosaic controller. Complex lighting shows as well as devices like moving lights, color-mixing LEDs, conventionals, and dimmers can all be controlled by Tessera. It also handles impromptu show control, accessories, automation, waterworks, and other non-lighting effects.

"Imagine color-changing lights in the lobby of a mall or an office tower that can go through dynamic effects, seasonal looks, or subtle lighting events—without requiring a massive control system that no-one knows how to use," says Bokelman. "Tessera provides simple access, standalone touchscreen control, at your fingertips. Tessera is a complete controller, capable of mastering an entire installation—while also integrating with a larger Mosaic installation." ■

## New 20W AC/DC LED-Driver with PFC Is Flicker-Free Dimmable to Zero

TRIAC-dimmers were originally designed to dim incandescent filament lamps. The use of CFL lamps already causes many problems and the story is continued with LED lamps. LED lamps are what we will be illuminating our houses and public/commercial rooms with in the future.

The use of TRIAC-dimmers in LED-systems causes unwanted flicker, visible to the eye, due to phase modulation. This prevents linear dimming of LEDs down to zero. If existing TRIAC-Dimmers are to be used with LED-systems, a new type of LED-Driver is required.



**RACT20 20W AC/DC-LED-Drivers with PFC promises flicker-free dimming down to zero**

RECOM's new RACT20 AC/DC-driver family can be dimmed linearly and without flicker from 100% down to zero. It is equipped with a specially developed TRIAC input, which is not affected by the PFC-circuit. An ideal solution for many LED-systems, where dimming is easy.

These new AC/DC-drivers are available with either 230 VAC or 115 VAC input. They offer 20 W and can support 5 to 15 power LEDs or LED-chains, with constant currents of 350, 500, 700 or 1050 mA. The power factor (PFC) is >95% and therefore better than required by EN61000-3-2 and meet class C requirement.

RACT20-drivers are designed for indoor applications, class IP20. They are EN/UL 60950-1 certified with a "Design Lifetime" >70.000 hours. Warranty is 5 years. ■

## BAG Launches New Electronic Control Gear for LED Modules

BAG unveiled the ZITARES range of electronic control gear for direct current operation of LED modules with a nominal service life of 50,000 h, designed for flexible, efficient use in professional lighting applications.



**The ZITARES range of electronic control gear for LED modules from BAG electronics features compact design and high energy efficiency**

**High performance, low volume:**

Dim and non-dim versions come in an identical housing; luminaire manufacturers can switch between both without any additional effort in design or manufacturing. Inside their compact build, ZITARES offer high performance density.

**High energy efficiency requirements of 2015 fulfilled today:**

ZITARES drivers achieve a stand-by value after DALI switch off of only 0,3 W, fulfilling all current requirements and reaching the standard that will come into effect in 2015. The energy efficiency ratio is 93 %.

**One electronic control device for a wide range of LED power types:**

The ZITARES ECG with 1, 2 or 4 channels cover a power current range from 350 to 2800 mA, allowing performance up to 140 W. The dim version is available with either a 1 – 10 V or a DALI interface with combined push-dim function. Flexibility is further enhanced by free choice of output current in multichannel versions.

**Electric shock protection and SELV:**

The output voltage of all devices fulfill the stringent SELV-standards („safety extra low voltage“). This offers protection against electric shock and safety in operation. Due to the SELV standard no additional measures need to be taken to insulate the LED modules that are linked to the ZITARES ECG. This, in turn, has a positive effect on the luminaire's heat management. ■

## IST Invents World's Widest Dimming Dynamic Range LED and OLED Driver

Integrated System Technologies (IST) Limited announces it has invented the world's first commercially available LED driver that can control the LED current from one millionth of an Amp to over 2.1 Amps in a single output stage. The breakthrough ultra-wide dynamic dimming ratio of 2,000,000:1 provides unparalleled LED current control. Unlike other driver control systems, no pulsing of the LEDs is needed to achieve the dynamic range.

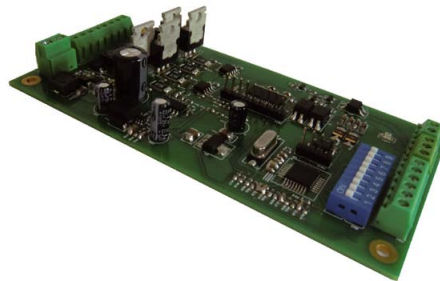

**IST's hybrid dimming technology offers unrivaled dimming control at very low light levels to replicate incandescent lamp dimming**

**Features:**

- Hot plugging without blowing the LEDs
- Short circuit protection not only to ground but other switching output stages
- Channel bondable in order to create higher current outputs
- Common anode compatible for multichannel colored LED fixtures
- Long life output stages, using solid-state capacitors with >300,000 hours
- Wide dimming dynamic range > 65,535:1 with no pulsing
- Software programmable maximum forward current (1 uA to 2100 mA)
- Extremely low RMS ripple current (<5%)
- Software programmable switching frequency (30 kHz to 120 kHz)
- Healthy driver compliant with DC output current (no pulsing)
- Wide LED/OLED forward voltage range (1 V to 48 V)

Traditional LED drivers that use DC dimming usually have a limited current dimming ratio well below 256:1 and even LED drivers that utilize current pulses through the LEDs often only achieve 16-bit resolution in theory and 10-bits in practice, which culminates in lower color and contrast control of LED fixtures.

The IST research and development team has spent the last 18 months developing and perfecting a new dimming control technique that has visual health and healthy lighting systems right at its core. The new healthy driver systems are built upon IST's iDrive® digital signal processing (DSP) platform and provide 16-bit DC dimming with exceptionally low LED RMS ripple current of less than 5%. The system is able to control the LED or OLED forward currents down to 1 millionth of an Amp and offers up to 98% stage efficiency at a maximum forward current of 2100 mA.

The new hybrid dimming technology will be available as standard in the iDrive® Quad 120W 4 channel iDrive® Force 24 720W 24 channel iDrive® Force 12 240W 12 channel iDrive® White Knight 32 720W 32 channel and iDrive® Quattro CC 400W DC/DC LED drivers. ■

## New SynJet® LED Cooling for Lumileds LUXEON S

Nuventix announced the availability of a new LED cooling solution utilizing SynJet thermal management for the Philips Lumileds LUXEON S.



**Nuventix's New SynJet® for Luxeon S combines small size with high cooling performance to maintain long lifetime and highest efficiency**

The solution is based on the SynJet Par20 Cooler 24 W, which combines reliability, small size, and near-silent acoustics inherent with SynJet technology with a new mounting pattern for an easy plug-and-play solution for cooling spotlights and track lights. The Par20 Cooler cools the LUXEON S in an ultra-compact 66 mm diameter solution.

The solution was developed for the Philips Lumileds LUXEON S LED, which delivers the "Punch" and "Sparkle" for illumination and quality of light. ■

## Shuoen Launches Graphite Heat Sink for MR16 LED Bulb

Shuoen launches two graphite heat sinks for MR16 LED bulb with models no V304 and V402. These two new innovative LED graphite heat sinks adopted Shuoen's patented porous graphite manufacturing method technology. The heat sink using porous graphite provides good heat conductivity and large specific surface area to transmit and dissipate heat away from LED heat source very efficiently.



**The graphite heat sinks are available for up to 500 lm / 7W MR16 LED bulbs for replacement of current 50 W MR16 halogen spots**

The MR16 V304 graphite heat sink, equipped with 32 fins, is designed for high-power MR16 LED bulb with max power up to 7 W. The heat dissipation ability of this product is similar to those high-end cold-fin aluminum heat sinks in the market.

The MR16 V402, a finless graphite heat sink with heat dissipation ability up to 6 W, aimed to replace all current aluminum extrusion or die casting heat sinks with better performance and similar price, and it is designed for mid-level MR16 products.

Shuoen also provides graphite heat sinks with different colors including silver, black, red, yellow, blue, green, purple, orange and etc.

In addition to the current product line, Shuoen is also developing other graphite sinks for indoor LED lighting, including the heat sink for 7 W MR16, A19 LED bulb, LED candle light, LED Par lamp, and etc. The graphite sink for 7 W MR16 is designed for the highest level MR16 with 500 lm for replacement of current 50 W MR16 halogen bulbs, and engineering samples can be provided to LED bulb manufacturers for testing. ■

## DK Thermal Solutions Offers Formable Thermal LED PCB Solutions

A unique proposition is Formable Thermal LED PCB Solutions, made from ceramic-filled fluoropolymer composite base material for IMS-based Power LED applications.

This enables the LED lights to be directed in the optimum direction for any application, which gives a better light yield, making your application more efficient. Applications such as garage lighting, street lighting or medical lighting are ideal for formable PCB solutions.

How does it work? After manufacture and assembly the boards are able to be bent or formed using a jig system. Nearly any shape is possible, without X or Y limitations. The advised bending angle per section is up to an angle of 70°. So one is able to make a full circle of 360° in a number of sections via multiple bending, or an arch or another bent shape, without the MTBF (Mean Time Between Failure) being affected.

The Formable Thermal PCB solutions are made specifically for the needs of the application at hand. At DK Thermal Solutions we design the boards specifically to your needs and to your design. If needed, DK Thermal Solutions can also take care of the assembly into a complete unit for you. ■



**Close-up of a formable thermal LED PCB solution from DK Thermal Solutions**

## Jaro's MR-16 Coolers Utilize Aerospace Fluid-Bearing Technology

Inspired by expertise from the Aerospace Industry, Jaro's new tightly-designed MR-16 LED coolers optimize longevity and temperature with a highly-efficient fluid-bearing structure.



**Jaro's MR-16 cooler provides a very low noise level of max. 20.6 dB(A) and almost no detectable vibrations**

At speeds of up to 4200RPM±15%, these very quiet DC coolers provide a chilly, yet quiet air-flow of 1.85 CFM. Specifically designed for LED cooling applications, these coolers are sized at 30 x 30 x 7 mm and operate from -20°C to +90°C.

Due to a perfectly balanced design (where the vibration grade = G1- ISO 1940 standard), these coolers operate with miniscule levels of detectable vibration. By avoiding mechanical friction, JARO's AFB bearing provides an impressive 70,000 hours of long life at 40°C.

In addition, less friction also offers a virtually-silent operation. Operating at a quiet 18.6dB (max.:20.6dB(A)), these coolers are at the cutting edge of low-level-noise performance.

As the cooler starts to rotate, a high quality aerospace grease lubricates the chamber from the outside of the bearing - moving in. This forms a film between the shaft & bearing which greatly reduces friction & supports the rotating speed. ■

## Essemtec Launches Hydra, the New 3-D Dispense and Placement System

Until recently, specialized machines were required for SMD assembly of 3D-MID. Essemtec is now presenting an absolute world's first with Hydra. Hydra is the first standard machine for dispensing and assembling in 3-D that easily can be integrated into a production line. Hydra allows for fully automatic production with low manufacturing cost.



Essemtec's Hydra dispense and placement system allows 3D placement of electronic components, including LEDs

Essemtec has developed Hydra in a close collaboration with a producer of 3D-MID products. The system operation of Hydra is similar to a standard SMD pick-and-place machine. Therefore, it can be integrated easily into a typical electronics production.

Essemtec combines a standard 2-D SMD pick-and-place of the Paraquda series with a 6-axes robot. The robot positions the substrate holder so that the placement level is always horizontal. Because of this concept, the 3-D assembly machine Hydra is able to use the same component feeders as a normal SMD placement machine, the same spare parts, the same vision system and even the same pickup tools. The Paraquda's software and control system is simply expanded by a robot controller.

The Hydra can dispense glue in nearly any position and assemble SMD components accurately. The 4-axis pick-and-place head can place up to 2,500 cph in 3-D mode and up to 7,000 cph in 2-D mode.

The placement area is specified at 300 x 160 mm. The placement axes features a vertical travel range of 50 mm and, therefore, can place components into deep cavities. The component range spans from 01005 up to 20 x 20 mm with a maximum height of 18 mm. The machine features an inline conveyor system and quick changeover, making it capable of series production as well as small series and sample manufacturing. ■

## Mentor Graphics: Integrated Solution for Component-to-System Thermal Characterization and Analysis

Mentor Graphics Corporation announced the electronic industry's first combined technology for thermal characterization and simulation with T3Ster® hardware test products and its FloTHERM® software.

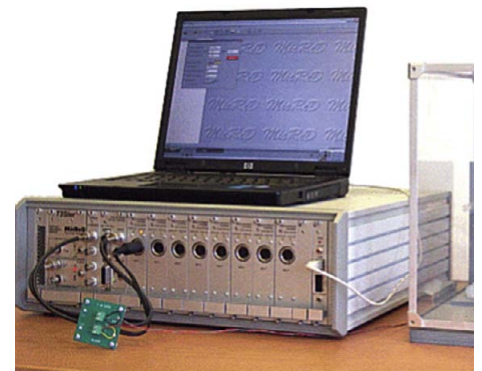

Testing an MR16 LED lamp with Mentor's T3Ster thermal tester

Increased design complexity and smaller form factors create heat management problems which represent one of the biggest challenges in electronics. Now the integration of Mentor's T3Ster hardware measurement and FloTHERM software simulation provides a combined methodology of optimizing heat management in devices, sub-systems and full systems.

Manufacturers are able to optimize their LED and IC package designs for effective heat dissipation. Once the device prototype is built, they can then characterize the device from a thermal perspective and build accurate models for use in FloTHERM thermal software simulations at both the sub-system and full system levels. Finally, systems integrators can further verify their heat management solutions with physical measurements using the T3Ster hardware.

JEDEC is the organization dedicated to microelectronics industry standards. The Mentor Graphics T3Ster advanced thermal characterization tester for semiconductor packages is the only commercially available product to fully implement the JEDEC JESD51-14 new measurement methodology standard for the junction-to-case thermal

resistance of power semiconductor devices. The T3Ster test methodology ensures higher accuracy and repeatability compared to classical steady-state measurements based on older standards.

Mentor's FloTHERM product allows engineers to implement virtual prototypes using advanced CFD techniques to simulate airflow, temperature and heat transfer in electronic systems. When combined with the T3Ster, engineers using the FloTHERM tool will benefit from both accurate thermal simulation models derived from real measurements and thermal package characterization testing.

Package characterization measurements provide an insight into the package structure with thermal resistances and thermal capacitances. Simulation software provides the engineer with information on specific sections of the design that corresponds to the measured structure. Thermal interface materials are quite difficult to model since their conductivity and thickness cannot be determined with high accuracy. Thus, thermal package measurements produced by the T3Ster product, based on the resistance of these materials, can be used later for accurate model creation in FloTHERM software. This seamless process provides fast, easy and accurate model creation; identifies product design defects; and enables manufacturing quality checking.

This system is compatible with other Mentor Graphics products to provide comprehensive thermal simulation for optimum system reliability, from IC package and LED, to PCB, and to full system development. ■

## opsira Offers Flexible Goniometers for Multiple Applications

opsira GmbH offers more than 20 different standard types of goniometers, based on the two fundamental models gonio2pi and gonio4pi, for the measurement of light sources, luminaires and scattered light distribution.

All opsira goniometers are directly driven, a principle that has indeed proven itself over many years as a tried and tested method, with absolute encoders enabling a very high measurement precision without the need of a



**All versions of opsira's new goniometers offer a modular system design based on the two fundamental models gonio2pi and gonio4pi**

reference run. There are source imaging respectively ray data goniometers (type: -SI), pure scatter light goniometers (type: -BSDF) or combined systems (type: -SI-BSDF) available.

Furthermore the delivery scope of the goniometers can be extended by cameras for color measurement, by spectroradiometers as well as additional detectors in order to determine the angle dependent color behavior of light sources, luminaires or components.

Later upgrades of measurement applications are easily feasible due to the modular system design.

The gonioremove provides an external control of the goniometer via TCP/IP interface and presents a further option of the opsira goniometer scope. ■

## BJB: Automation Premiere in Asia

BJB, the world's leading manufacturer of components for the lighting and domestic appliance industry, had a successful premiere: In Asia at the Hong Kong International Lighting Fair, the German company presented its automatic wiring systems for the lighting industry for the first time. The response from trade visitors was overwhelming. "Our expectations were more than surpassed.

BJB has been exhibiting its products at the Hong Kong International Lighting Fair for ten years. This time, the German company did not only show connectors for LED lights and conventional lighting solutions, but also demonstrated the ADS ONE wiring system. This production cell has been designed as an entry-level model for automation and for the flexible wiring of smaller batch sizes.

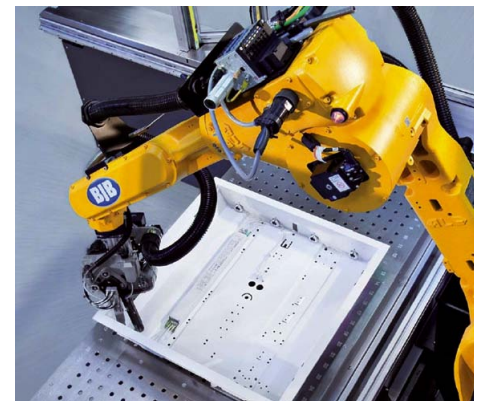

**BJB presented its automatic wiring systems for the lighting industry for the first time in Asia**

Olaf Baumeister: "The ADS ONE is so compact that it can be pushed straight into a container and transported without difficulty using a forklift. It is also very flexible and easy to operate. For companies which have not used automatic wiring systems before, this is important."

Luminaire manufacturers throughout Europe have been working with wiring systems from BJB in various sizes and specifications for a number of years now. ■



## New Method for Enhancing Thermal Conductivity Could Cool Computer Chips, Lasers, LED's and other Devices

The surprising discovery of a new way to tune and enhance thermal conductivity – a basic property generally considered to be fixed for a given material – gives engineers a new tool for managing thermal effects in smart phones and computers, lasers and a number of other powered devices.

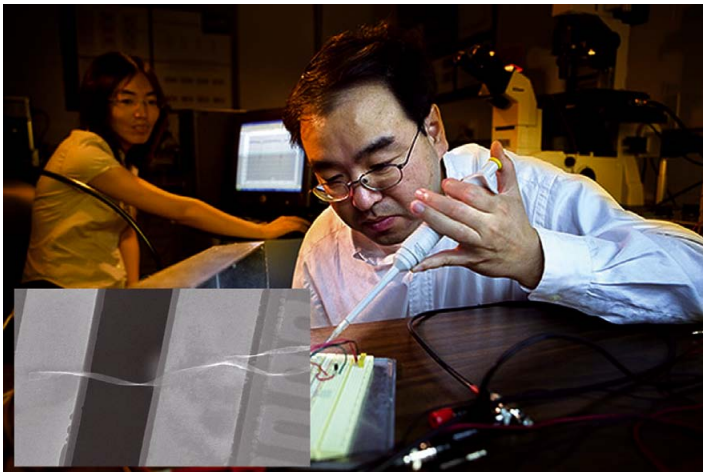

**Mechanical engineer Deyu Li in the lab and a pair of boron nanoribbons stuck together on a microdevice used to measure thermal conductivity (small image). (Courtesy of the Li Lab & Daniel Dubois/Vanderbilt University)**

Li and his collaborators discovered that the thermal conductivity of a pair of thin strips of material called boron nanoribbons can be enhanced by up to 45 percent depending on the process that they used to stick the two ribbons together. Although the research was conducted with boron nanoribbons, the results are generally applicable to other thin film materials.

**An entirely new way to control thermal effects:**

“This points at an entirely new way to control thermal effects that is likely to have a significant impact in microelectronics on the design of smart phones and computers, in optoelectronics on the design of lasers and LEDs, and in a number of other fields,” said Greg Walker, associate professor of mechanical engineering at Vanderbilt and an expert in thermal transport who was not directly involved in the research.

According to Li, the force that holds the two nanoribbons together is a weak electrostatic attraction called the van der Waals force. (This is the same force that allows the gecko to walk up walls.)

“Traditionally, it is widely believed that the phonons that carry heat are scattered at van der Waals interfaces, which makes the ribbon bundles’ thermal conductivity the same as that of each ribbon. What we discovered is in sharp contrast to this classical view. We show that phonons can cross these interfaces without being scattered, which significantly enhances the thermal conductivity,” said Li. In addition, the researchers found that they could control the thermal conductivity between a high and a low value by treating the interface of the nanoribbon pairs with different solutions.



## Accelerate Your Business with China's One-stop LED B2B Platform

- Expand Your Market Share
- Enhance Your Company's Brand
- Extend Your Business Network



ORGANISED BY



[www.greenlightingchina.com](http://www.greenlightingchina.com)

**For the Exhibition** Miss Sarah Geng, Tel: +86 21 2231 7030, sarah.geng@reedexpo.com.cn

**For the Forum** Miss Betty Xu, Tel: +86 10 8238 7600 xuny@china-led.net

**For Media** Miss Elaine Zeng Tel: +86 21 2231 7072, elaine.zeng@reedexpo.com.cn

The enhancement is completely reversible: One of the remarkable aspects of the effect Li discovered is that it is reversible. For example, when the researchers wetted the interface of a pair of nanoribbons with isopropyl alcohol, pressed them together and let them dry, the thermal conductivity was the same as that of a single nanoribbon. However, when they wetted them with pure alcohol and let them dry, the thermal conductivity was enhanced. Then, when they wetted them with isopropyl alcohol again, the thermal conductivity dropped back to the original low value.

“It is very difficult to tune a fundamental materials property such as thermal conductivity and the demonstrated tunable thermal conductivity makes the research especially interesting,” Walker said.

One of the first areas where this new knowledge is likely to be applied is in thermal management of microelectronic devices like computer chips. Today, billions to trillions of transistors are jammed into chips the size of a fingernail. These chips generate so much heat that one of the major factors in their design is to prevent overheating. In fact, heat management is one of the major reasons behind today’s multi-core processor designs.

“A better understanding of thermal transport across interfaces is the key to achieving better thermal management of microelectronic devices,” Li said.

Another area where the finding will be important is in the design of “nanocomposites” – materials made by embedding nanostructure additives such as carbon nanotubes to a host material such as various polymers – that are being developed for use in flexible electronic devices, structural materials for aerospace vehicles and a variety of other applications.

Collaborators on the study were post-doctoral research associate Juekan Yang, graduate students Yang Yang and Scott Waltermire from Vanderbilt; graduate students Xiaoxia Wu and Youfei Jiang, post-doctoral research associate Timothy Gutu, research assistant professor Haitao Zhang, and Associate Professor Terry T. Xu from the University of North Carolina; Professor Yunfei Chen from the Southeast University in China; Alfred A. Zinn from Lockheed Martin Space Systems Company; and Ravi Prasher from the U.S. Department of Energy.

The research was performed with financial support from the National Science Foundation, Lockheed Martin’s Engineering and Technology University Research Initiatives program and the Office of Naval Research.

The finding was made by a group of engineers headed by Deyu Li, associate professor of mechanical engineering at Vanderbilt University, and published online in the journal *Nature Nanotechnology* on Dec. 11, 2011. ■

## EU Project IMOLA Starts R&D on Large-Area, Intelligent OLED Lighting

Imec and its project partners announce the launch of IMOLA (Intelligent light Management for OLED on foil Applications), a project under the EU’s 7th framework program for ICT (FP7). The project’s goal is to make large-area OLED-based lighting modules with built-in intelligent light management. These systems will be used in future energy-efficient wall, ceiling and car dome lighting, where the light intensity can be adjusted intelligently, e.g. according to the time of day or weather conditions.

OLEDs are paper-thin, flexible and lightweight electronic devices. They consist of organic materials which emit light in response to an electric current. OLEDs consume up to 70%

less energy compared to conventional light sources. This makes OLED technology a prime candidate for the next generation of energy-saving lighting. But before flexible large-area OLED lighting can be commercialized, more R&D is needed to solve some outstanding challenges. These areas, which mainly concern the driving electronics, power distribution, integration and miniaturization, as well as sensors and application intelligence, will be tackled by IMOLA.

The IMOLA consortium includes industrial and academic partners that are leaders in their field of expertise. Next to imec, the project coordinator, the partners involved in IMOLA are TNO/Holst Centre (Netherlands), Philips Technologie (Germany), NXP Semiconductors (Netherlands, Belgium), Hanita Coatings RCA (Israel), Henkel Electronic Materials (Belgium), Centro Ricerche Plast-optica (Italy), and the FER department of the University of Zagreb (Croatia).

IMOLA’s application demonstrators in the areas of car and wall lighting will raise public awareness and acceptance for environmental-friendly OLED lighting. In addition, IMOLA will help create a common OLED infrastructure on a European scale. IMOLA’s R&D results will help to give Europe a leading edge in OLED fabrication, especially in the field of high value-added applications, such as automotive lighting. ■

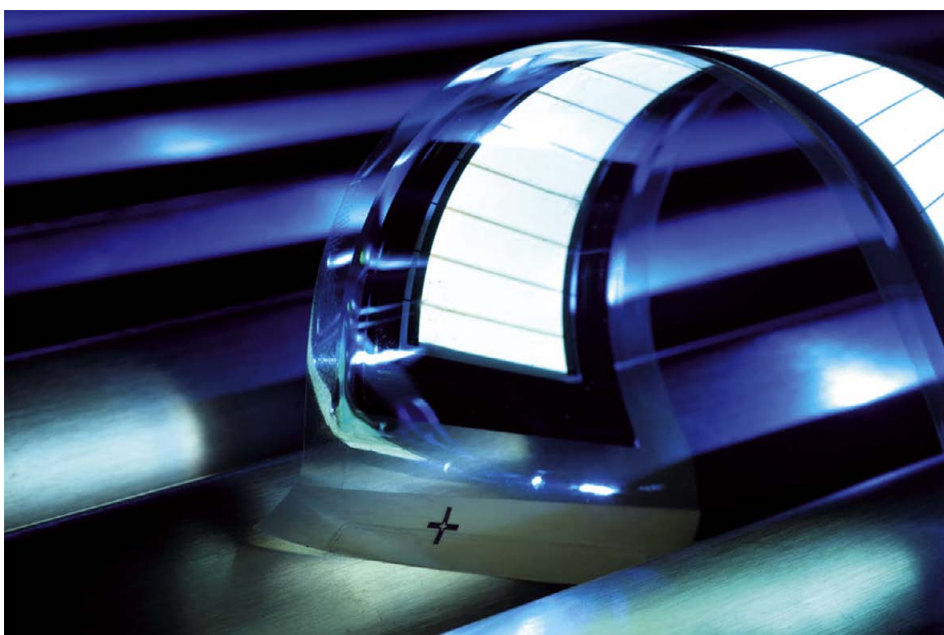

Transparent organic light-emitting diode on foil (Courtesy of TNO/Holst)

**LED**  
professional

**SYMPOSIUM  
+EXPO**

**LpS 2012**



**CALL FOR PAPERS**  
[www.lps2012.com](http://www.lps2012.com)

# LED Lighting Technologies

International Winning Approaches

**25-27 SEPTEMBER 2012 | BREGENZ | AUSTRIA**

**CONTACT:** LUGER RESEARCH | Moosmahnstrasse 30 | 6850 Dornbirn | T +43 5572 39 44 89 | F +43 5572 39 44 89 90  
[info@lps2012.com](mailto:info@lps2012.com) | [www.lps2012.com](http://www.lps2012.com)

**e.lumix®**  
Technologie AG

**OSRAM**  
Opto Semiconductors

**TRIDONIC**  
▼ enlightening your ideas

# Organic Light Emitting Diodes (OLEDs) Continue to Advance

Alan R. Mills reports for LED professional from the OLED Summit Conference hosted by InterTech-Pira. He shows technology and market progress in small OLED displays, today's volume products, large OLED displays and monitors, like the 55 inch OLED TV, recently announced by LG, and OLED lighting, which is perceived to be an important market in the future. In addition he has a look at China's activities in OLED technology.

## Small OLED Displays

At the recent OLED Summit Conference hosted by InterTech-Pira it was apparent that the organic light emitting diode (OLED) small display market has been growing at a breakneck pace, hence the 2011 small display market will double to 80 million units and reach \$1.5 billion (up from about \$1 billion in 2010). This growth was mainly fueled by the large investments in capacity made by Samsung Mobile Displays (SMD), a company with the only Generation 5.5 OLED manufacturing fab at this time. The main OLED market is cell phone displays with smaller market shares in cameras, MR3s,

tablet PCs and photo frames, where the vast majority have a smaller than 5-inch diagonal. Samsung and Nokia are the biggest OLED display users with RIM and Motorola presently exhibiting low interest levels. The three main countries that supply small OLED displays are Korea, Japan and Taiwan although Japan has been losing market share due to Samsung presently having more than an 85% share of the OLED small-display market. However, LG has already demonstrated 3.7-inch full-colour OLED prototype displays and expects to be in a full production mode by the end of 2011, with a presumed 300+ pixels per

inch format and an anticipated market share growing to about 20% by 2015. Some forecasts are predicting the small and medium OLED display market to achieve more than \$10 billion and a total OLED display market of \$22 billion by 2018, a goal that was supported by the introduction of a 7.7-inch tablet by Samsung in late 2011.

SMD continues to dominate this market with such models as its Galaxy-S phone with its 4-inch display and 235 dpi resolution, although Google is in the market with the Nexus-S and similar size and resolution. In the 7-inch OLED display category Kodak offers a digital photo frame. SMD may extend its market leadership and capacity with the introduction of an OLED note tablet by Q-1 2012, which will be sensitive to either stylus or finger touch. The OLED display forecast is shown in Figure 1. SMD is also planning to introduce small OLED displays for portable games and flexible OLEDs in 2012. The latter could be quite an achievement since IHS reported that most barrier systems do no better than keep moisture or air penetration to  $10^{-3}$  grammes per square metre per day, which is quite a long way from the necessary  $10^{-6}$  to  $10^{-8}$  g/M<sup>2</sup>/day anticipated for a long-lived flexible OLED display. The larger the display the greater the moisture barrier challenge!

**Figure 1:**  
For the next few years the display market will stay the key market for OLED manufacturers

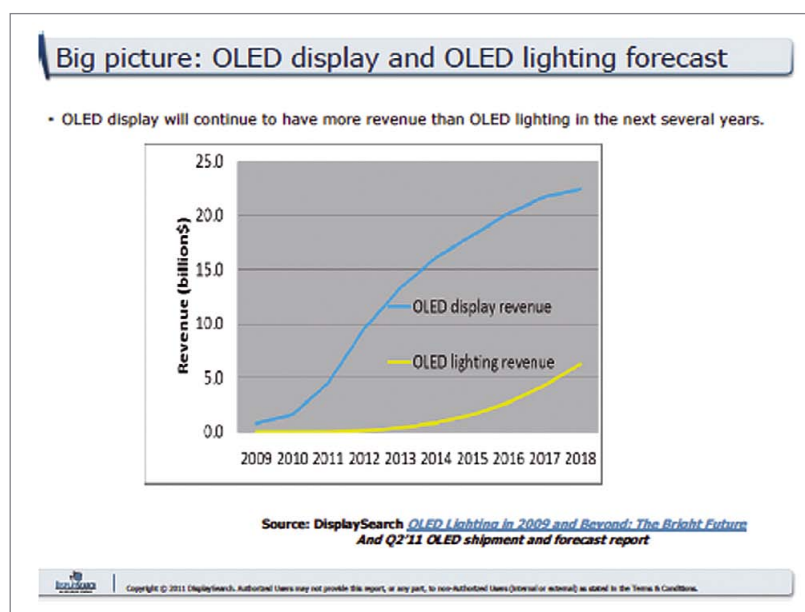

**Figure 2:**  
Currently, the main impetus for growth are mobile phones and DSC tablets. TVs will provide future growth opportunities

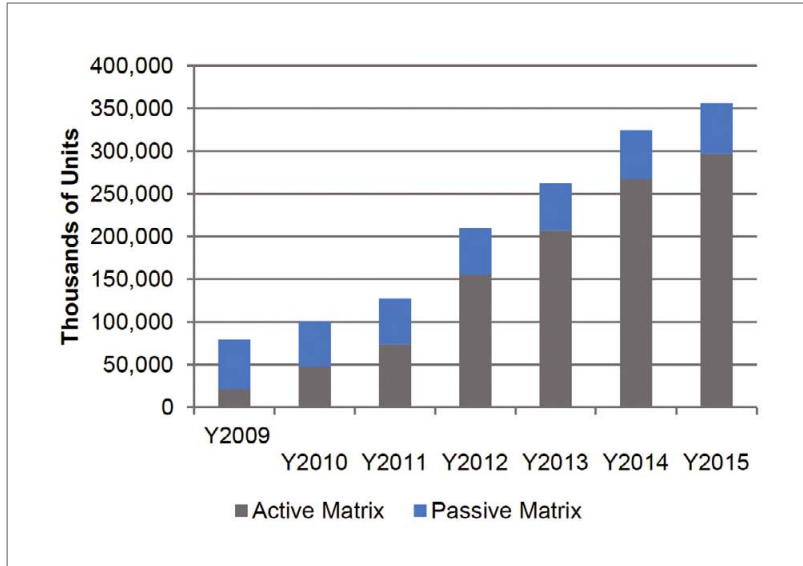

It should be noted that the cellphone display market growth is occurring even though OLED displays are estimated to be double the cost of similar LCD based displays. Vinita Jakhanwal from IHS-iSupply has forecast this market to grow to 300 million display units by 2015 including 235 million cellphone displays that would be part of a one billion smart-phone market and their Display Pixel Forecast is reproduced in Figure 2. The Pentile Matrix formats are also being used to improve pixel resolution. Apple, however, is showing less interest in using OLED displays at this time, probably for a few reasons. One is that their iPhone 4 has a resolution of over 300 dpi (compared to 235 for the Samsung Galaxy-S); two is that a single-main-supplier situation may not fulfill their manufacturing requirement model and three, the present IP situation between Samsung and Apple is somewhat adversarial, consequently Apple is not expected to use OLEDs before 2014.

In spite of the rapid market successes, there are still performance issues that could slow OLED market penetration. They include displays costs, manufacturing yields, thin film transistor (TFT) backplane technology (amorphous silicon, low temperature poly silicon, mixed oxides e.g. indium, tin, zinc), display lifetimes (especially with respect to blue emitters), light output-coupling and materials usage.

Materials utilization is very important because many are more costly than gold at this time with prices in excess of \$1,000 per gram. Present utilization is reported to be as low as 7-10%, but it is expected that new materials, higher generations of fabs and/or commercial adaptation of Roll-to-Roll deposition processes will raise materials utilization to the 50-70% range, a necessary factor competition with large LED displays.

### Large OLED Panels and Monitors

2011, there were no OLED TVs on the market (probably due to their relatively high cost!!), but LG announced to introduce an AMOLED TV at CES 2012 and Mitsubishi has demonstrated a 100-inch PMOLED (passive matrix) tile display that could be used as a TV format. There is a small OLED lighting market that is based on groupings of white, 150mm square panels (e.g. four to eight) that are incorporated into artistic, freeform, low intensity, luminaires, where cost is not a big issue and the disperse light form is claimed to be a key feature. According to Display Search, companies that are actively developing OLED lighting include large multi-national companies such as GE, Konica-Minolta, Lumiotec, Osram, Philips and PIOL, plus luminaire makers Acuity Brands Lighting and Linternity from Novaled AG.

The large display applications include TVs, public signage and monitors and there is one large OLED display market in which OLED displays are in short supply and in which they command a premium price. It is a specialised segment where OLED displays or monitors are used to analyze and monitor media or film production for broadcast and cinema and provide quality control for DVD and BlueRay and other entertainment products. In this market Sony Electronic Inc. has an almost complete monopoly. These high end professional product OLED displays are based on over 15 years of developmental experience with the first AMOLED being delivered in 2004 and which now incorporates a range of models with 15 to 25 inch display formats are that quite sophisticated, in short supply, and that command prices in the \$5,000 to \$30,000 per unit range.

Gary Mandle from Sony noted that all these test monitors are fabricated on one production line and they are graded into two quality ranges by performance analysis. The best and high-end monitors are the recently introduced Trimaster lineup that includes the BVME model range with those remaining falling into the less expensive BVMF price range. These test monitors provide 1920x1080P resolution with their useful color-matching lifetimes being about 30,000 hours and these are used as reference displays for the various forms of video media. They also offer the film studios, investors and other interested parties composition and/or digital intermediates for daily reviews of all video production in very high resolution and with accurate colour rendition. This exacting OLED technology accepts zero dead-pixels, long term stability and provides multiple format monitors that meet US and European standards, a capability that leads to a two-month backlog on the \$26,000 BVME model. Some monitors use GPS to control camera movements for cameras up to 40 feet away and these OLED monitors boast of 'perfect' tracking, ~12 microsecond response times, intense black levels that are reported to be better than LCDs at this time.

**Figure 3:**  
Recent trend of monthly sales of LED bulbs in Japan (credits Panasonic Idemitsu OLED Lighting Co.,Ltd.)

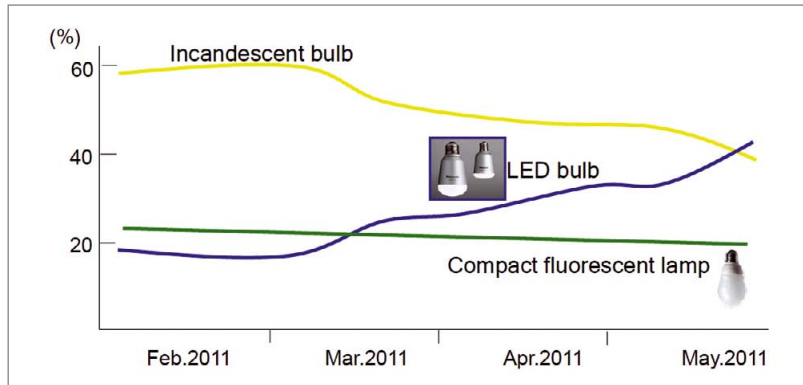

This monitor technology could eventually lead to commercial TV product lines for Sony when costs can be reduced. However, competition will be intense with LED performance rapidly improving. It is worthy of note that 32-inch Haier LED/LCD model TVs, with one million to one contrast ratios, have been recently on sale for \$249 and LG has offered a 23-inch 1080P LED monitor with a 5 million to one contrast ratio for \$159, with both being in the California market. James Lee from LG Display reported at the InterTech-Pira OLED Summit that their next OLED TV will be offered in 2013, by which time LED TVs are expected to account for more than 60% of the consumer TV market. With Vacuum Thermal Deposition and encapsulation process costs being high for OLED backplanes, lighting and TVs, OLEDs may be slow to match LED TVs in cost. Thus, it has been proposed that Generation-8 production lines with ink jet printing will be required before OLED TVs can be cost competitive with LED TVs. And, IHS-iSupply has forecast a less than 1% OLED TV penetration in 2015 out of a 300 million unit LED TV market.

With more than 100 players in a relatively small market, some consolidation is to be expected and was recently in evidence as Samsung announced the purchase of a small investment in Novaled AG. The interest of other large players in the OLED display market is indicated by the investment of hundreds of millions of dollars by companies in the EU, Japan, Korea and by the USA by the formation of the joint venture company PIOL by Panasonic Electric Works and Idemitsu Kosan Ltd., (Panasonic- Idemitsu-OLED-Lighting Co. Ltd.) with the announced goal “to make the best

OLED panel” on the market, presumably when using Idemitsu’s “World’s brightest blue emitting material”. This JV should help Panasonic Electric Works to maintain its position as the number 2 luminaire manufacturer in the world.

### OLED Lighting

Since early 2011, there has been a rapid incandescent bulb replacement drive in Japan and PIOL has been supplying LED replacement lamps into this market since that time. Takao Miyai from Panasonic reported that by mid-2011, LED lamp sales had exceeded those of incandescent lamps, see Figure 3. Additionally, PIOL introduced 8 x 8 cm OLED lighting panels in September 2011 that offer CRIs above 90 with efficiencies greater than 30 lumens per watt. These energy saving products are being sold on the open market through Panasonic Electric Works, with the subdued or disperse OLED luminaire light output being recommended for medical, art and museum lighting applications because of the lack of IR and UV content. Takao Miyai from Panasonic has reported a comparison of OLEDs and LEDs (Table 1) and has forecast that after 2020, OLEDs and LEDs will

share the lighting market, but that LEDs will have superior cost performance through 2030! PIOL’s OLED lighting efficiency goals are to achieve 100 lm/W in 2015, rising to 130 lm/W in 2018.

As reported earlier, OLED lighting and large displays are a more difficult proposition than the small OLED displays that already exceed \$1.5 billion in market size. OLED lighting will be a disruptive technology for the lighting industry (similar to LEDs) and requiring 3x to 7x the luminosity of a small OLED display. But, lighting designers and companies such as Acuity Brands Lighting Inc., and Novoled AG, are already exploiting four- to eight-inch rectangular OLED panels to offer artistic and ‘quality’ light sources to lighting architects for advanced projects that would fit into the ‘Beyond Bulbs and Lamps’ category of the future. In keeping with this concept, Acuity introduced its Revel™ design at the 2011 Light Fair exhibition. This simple rectangular freeform OLED luminaire uses a grouping of 300 lumen, 6x6-inch square OLED panels (e.g. five) that provide a diffuse light with reported efficiencies of 60 lm/W and that elicited a judges comment in the Edison Report publication ‘it’s a great looking luminaire’. With a price in the \$7,500 range Linternity® recently introduced the Victory™ model, an OLED desk lamp that is even more expensive than the Acuity OLEDs. It is a top of the range deluxe desk-top lamp fabricated from carbon fibres and uses four rectangular OLED panels rated at 16 watts to produce ‘warm white’ illumination, with a reported useful lifetime of 10,000 hours. Although these luminaires are relatively expensive, they are designated as the ‘cream of the crop’ by their

	LED	OLED
Common Features	<ul style="list-style-type: none"> <li>• No or less UV, IR emission</li> <li>• High efficacy at low temperature</li> <li>• No toxic material complying RoHS(e.g., mercury)</li> <li>• High response / easy dimming</li> <li>• Low voltage DC drive</li> </ul>	
Pros	<ul style="list-style-type: none"> <li>• Long Life</li> <li>• Good for directional lighting</li> <li>• Small and compact</li> </ul>	• tbd
Issues	<ul style="list-style-type: none"> <li>• Glare solution</li> <li>• CRI improvement</li> <li>• Cost reduction</li> </ul>	<ul style="list-style-type: none"> <li>• Life time improvement</li> <li>• Efficiency improvement</li> <li>• Size up</li> <li>• Cost reduction</li> </ul>

**Table 1: Comparison of OLEDs and LEDs (Credits Takao Miyai / Panasonic)**

**Figure 4:**  
In 2010, roughly 1% of LEDs were used for indoor lighting in China but a strong increase is expected for the near future

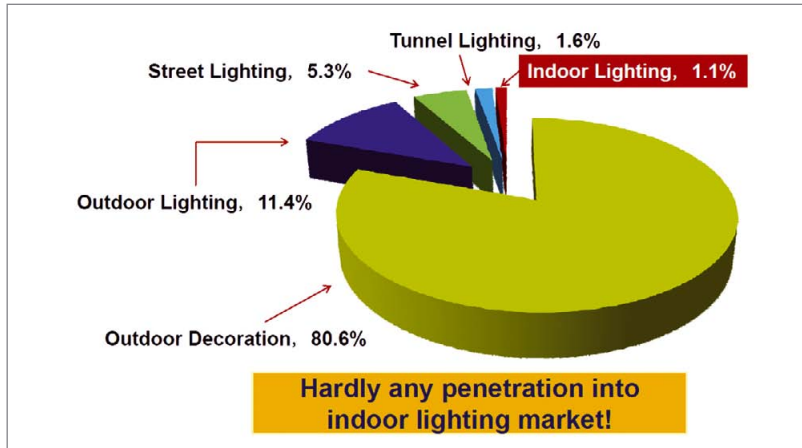

proponents and seem to be well received by the architectural lighting community that is looking for new lighting concepts. According to Jeannine Fisher from Acuity, they bring soft feelings to "hard lighting".

Since the introduction of the Revel™ luminaire with five panels, Acuity has added the Kindred™ model luminaire with a curved canopy format that supports a larger number of the 6-inch OLED panels. PIOL has also joined this group with a thin (2.11 mm) light weight (38 g.) OLED lighting panel that has a luminance of 3,000 candela per square metre, a CRI above 90, an efficiency of 30 lm/W (projected to be 100 lm/W in 2015) and an extrapolated lifetime to 70% luminance of more than 10,000 hours. Display Search has forecast the world OLED lighting market to be \$200 million in 2012, \$1.5 billion in 2015 and growing to over \$6 billion by 2018.

### OLED Lighting Comes to China

OLED lighting manufacturing is now being established in China with the formation of First O-Lite Company (FOL), a private start-up, presently with about 20 technical employees. It is located in Nanjing and presently it is the first and only Chinese OLED lighting company. Yuan-Sheng Tyan, who has over 40 years experience in OLEDs and was a former member of the Kodak OLED team, had previously tried to start up an OLED lighting company in the USA, but could not raise significant dollar funding. However, the situation is very different in China where the Chinese government is keen to get ahead in the

world in the 'green lighting' field with a gradual phasing out of incandescent bulbs to zero units by 2020. Thus, it has allocated more than a billion dollars for LEDs and OLEDs in its latest 5-year plan in order to reduce the approximately 28 tonnes of mercury used in China to make the estimated 5 billion CFLs produced per year (out of a world demand of 20 billion CFLs). This 5-year plan also includes the refit of 10 cities with 10,000 LED street lights each as part of an estimated \$7.8 billion Chinese LED lighting market in 2013. It also includes the large 2010 Chinese Lighting market, which was mostly for outdoor use (Figure 4). In spite of their undesirable mercury content, CFLs can receive up to 90% combined subsidies in China and are expected to save 48 billion kWh per year until replaced by OLEDs and LEDs.

At this time, there is about 1% penetration by LEDs and zero OLEDs into the Chinese indoor lighting market with rapid growth planned for the future. Yuan-Sheng, from FOL, expects the LED industry to try to dominate this segment, even though high quality LED chips for indoor lighting presently have to be imported into China. FOL plans to focus its OLED lamp penetration on the local Chinese construction market, which he estimates to be half of the world new construction market. Of this volume, an estimated 50% of the Chinese new construction indoor lighting market segment will be available to OLEDs. Additionally, FOL can count on a significant share of the approximately \$1.7 billion allocated for LEDs and OLEDs in this 5-year plan by the

Chinese government in order to achieve green or eco-parity with the rest of the world. FOL was established in 2010 and its R&D operation and chemical laboratory are developing materials, layer structures and light extraction technologies for its future OLED products and with planned expenditures of about US \$25 million by the end of 2012. FOL's Gen-1 pilot line should be running by the end of 2011 with plans to have its Gen-2 facility on line with pilot production in the second half of 2012 and demonstration projects with Nanjing and other municipalities are also planned for the 2012-13 period. Expenditures of \$100 million have been budgeted for the installation of a G-6 OLED Fab by 2015. FOL accepts that today's estimated costs for OLED lighting are too expensive at \$1,800 per square metre for 2012 (based on the 2011 Workshop and Roundtable roadmap forecast), but projections for future cost competitive OLEDs are based on the same roadmap for OLED lighting costs with reported values of \$180 per kilolumen in 2012, declining to \$25 in 2015, a value that must be reduced to \$9 per kilolumen in 2020 for market integration. This could be a rapid price decline target to achieve in an eight year period and will require very high production volumes. It should be compared with the recent US DOE Manufacturing Roadmap target for LEDs where the kilolumen values are close to an order of magnitude lower for a similar time frame at only \$2.20 per kilolumen in 2015 and \$1.00 per kilolumen by 2020.

In summation, the small-display OLED market will continue to show strong growth, but the OLED TV and lighting markets may encounter stiff competition from LED products due to the pressure from lower costs and from the continuing performance enhancement of LEDs and competing LED products. The competitive pressure on OLED lighting could be very relevant due to the recent offering of ultra-thin, diffuse light, rectangular LED panels with color control and high CRIs that are based on back lighting unit technology and that could easily compete with the present styles of OLED panel-luminaires. ■

# Microcontroller Based LED Drivers Initiate New Potentials

Alex Zaretsky, Lighting Segment Marketing Manager at Renesas Electronics Europe GmbH, explains the possibilities of lighting specific microcontroller solutions in an interview with Siegfried Luger and Arno Grabher-Meyer of LED professional. Renesas Electronics was founded in 2010 when NEC Electronics and Renesas Technology merged. It is the biggest supplier of microcontrollers in the world.

**LED professional:** How important is the lighting market to Renesas Electronics?

Mr. Zaretsky: From a strategic point of view, the LED lighting segment, for which we provide the brand new RL78/I1A ASSP family as well as the R2A20134 power IC and a wide range of MOSFETs and optocouplers supported by lighting specialized communication solutions, is one of the key markets for us which benefits from the increased focus from Renesas Electronics on a global basis. We invest heavily in the market by offering a range of advanced semiconductor solutions which are products dedicated to the lighting market covering a wide range of lighting

applications from LED retrofit bulbs. These range from professional indoor lighting to architectural and street lighting with integrated functions for DALI, DMX, RDM, ZigBee, and PowerLine communications. Our strategy is to provide solutions which enable the market trend, and therefore the company also plays an active role in the conception of future standards for the lighting industry as an active member of various standardization committees in Europe. In addition, Renesas Electronics is committed to environmental management and protection where lighting is one of the key opportunities for developing green and sustainable environments.

**LED professional:** It is obvious that Renesas focuses mostly on microcontroller solutions. What advantages do microcontrollers have for lighting applications?

Mr. Zaretsky: Firstly, the advantage lies in the versatility and flexibility of microcontrollers compared to firmly defined driver ICs. With the flexibility and programmability offered by microcontrollers, LED driver designers benefit from the single platform solution. Also, system changes can be applied much easier when controlled by software. In addition, intelligent systems do not require additional external components for implementing extra intelligence including PFC, DALI, DMX512 communications and sensor

**Figure 1:** Block diagram of the RL78/I1A  $\mu$ C and its typical integration in an LED driver

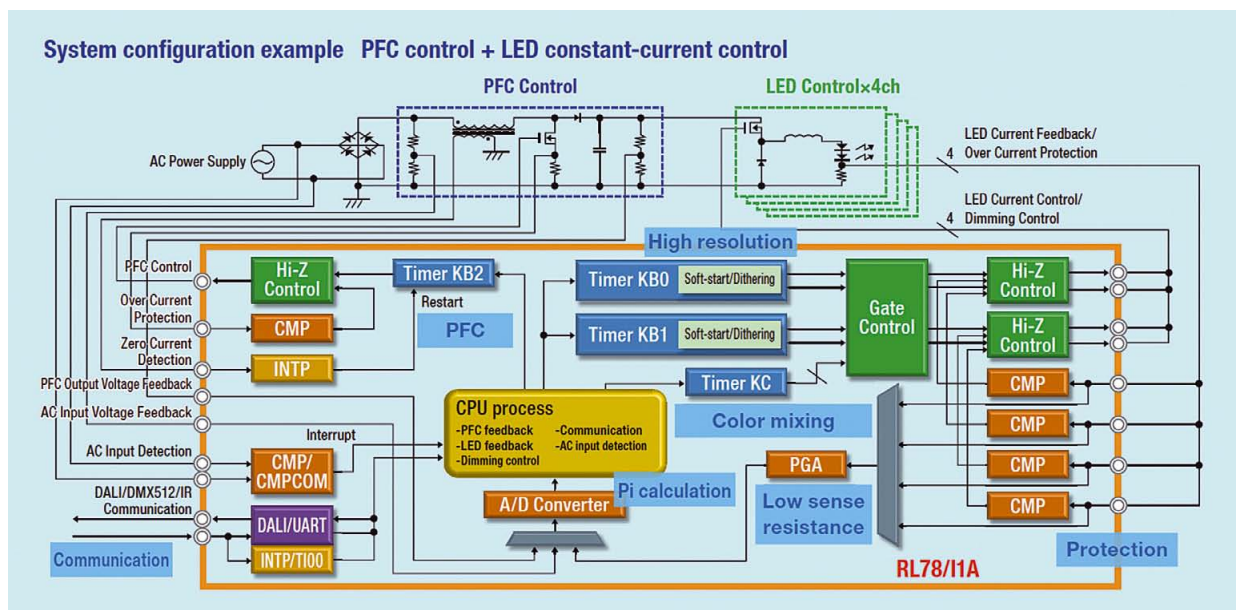

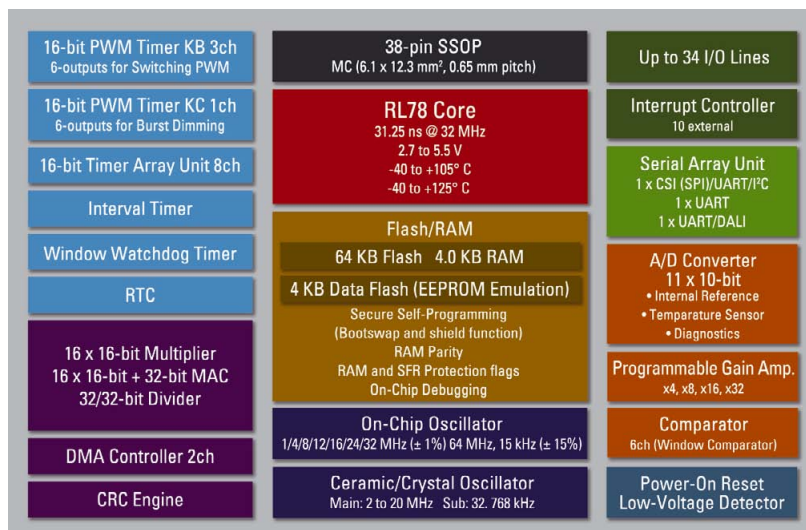

**Figure 2:**  
Detailed block diagram of the RL78/I1A  $\mu$ C showing all integrated features

processing because our lighting microcontrollers integrate all the required functions on board and provide a low cost single chip solution while keeping high efficiency. High integration allows reduction of external components which is quite important for many LED drivers and lighting ballasts, leading to cost and space savings.

**LED professional:** What are some of the key products that Renesas offers to the LED market?

**Mr. Zaretsky:** We leveraged the best features from our previous well known high performance microcontroller cores, 78K0 and R8C, enhanced the performance, reduced power consumption and combined them to create the brand new RL78 series. This new generation of microcontrollers provides the industry with the lowest power consumption in the world in its class and includes ASSP families for our focus markets including lighting. The new RL78 based lighting ASSP offers multi-channel LED control with individual 16-bit PWM dimming as well as 10-bit analog dimming for each channel. The new dedicated lighting series allows up to 64 MHz frequency for the PWM timers from the on-chip oscillator. This permits usage of small size inductors and wide bandwidth for constant current control. To support the power stage control, an integrated interleave PFC control function allows for various operation modes including CRM and DCM. Extended DALI transceiver is also integrated in the device together with all the standard interface functions such as UART, SPI, I2C. Most importantly, this microcontroller benefits from the clever internal architecture where the internal comparators and ADCs are interlocked with the PWM channels and the Op Amps are directly linked to the ADCs. This, in turn, allows for minimum CPU involvement and code size reduction while providing an automatic control of the system including driving LEDs, PFC control, DALI communications, sensor processing, over-current protection soft-start and more. We have also integrated our new technologies in the devices such as



snooze mode which permits ultra-low power consumption while processing DALI communications and performing A/D conversion as well as data flash which is capable of operating in the background while CPU executes instructions.

As part of our lighting portfolio, we also offer MCU products for low end LED driver applications as well as with multi-channel high power outputs capable of driving high brightness LEDs directly and supporting up to 1.5 A per channel. To extend the market coverage further we have released the R2A20134 - a PFC IC with a single channel LED driver specifically designed for low cost retrofit market.

**LED professional:** Energy consumption, especially in stand-by mode, is an important topic. What values can be reached today with microcontroller concepts?

**Mr. Zaretsky:** We developed the new low power RL78 series with a special snooze mode which lets you reduce the power consumption further and consumes only 0.1 $\mu$ A while performing the DALI communications. It is important to note that no information is lost when the system wakes up from sleep mode on the DALI interrupt. We believe this set of unique features will add great value to lighting applications in particular.

**LED professional:** The oscillator and the clocked system of a microcontroller especially cause EMI disturbance that can ultimately mean external expenses. What solutions do you offer in the direction of EMI?

**Mr. Zaretsky:** The RL78/I1A integrates a special soft-start circuit which means the inrush current can be reduced through LEDs.

At the same time, this leads to a reduction of electro-magnetic emissions. This concept has just been further optimized in the direction of EMI and interference emissions.

**LED professional:** It is always difficult to name a price but where do the component costs of an RL78 lie?

**Mr. Zaretsky:** The RL78 family is under one Euro in volume, but obviously this varies greatly depending on exactly what that volume is. Generally, our microcontrollers work with extremely optimized codes, which means the application dedicated internal architecture allows for the majority of the required functions to be implemented in the hardware. This way the memory footprint can be kept to a minimum and thus adds value to the overall cost of the chip.

We have already conducted some analyses and found that using the RL78/I1A in an LED driver design saves at least 20% on BOM cost when compared to alternative solutions.

# LED Lighting Taiwan

The 8th Int'l LED Lighting Exposition

## June 19 - 21, 2012

**New!**

**Looking for a product?  
Come join the buyer program with benefits!**



### Exhibits

- **LED Lighting Fixture**  
for Indoor, Outdoor, Specialty, Solar  
for Decorating, Landscape, Architecture, Garden  
Control System & Accessories
- **LED Applications**  
Automotive Lamps, Backlight,  
Display Board, Traffic Signal, IrDA, etc.
- **Package / Module**  
Lamp, Digital, Dot Matrix, Cluster, SMD, etc.
- **Epi Wafer / Chip**
- **Materials**  
Substrate, Ingot, Phosphor, Epoxy, Lead Frame, etc.
- **Processing Equipment**  
Wafer (MOCVD, Mask, Etching)  
Assembly (Dicing, Bonding, Packaging)  
Testing (Prober, Aging, Sorter)

### Organizer



Photonics Industry & Technology Development Association  
5F, No.9, Sec.2, Roosevelt Road, Taipei 10093, Taiwan  
Tel : +886-2-2351-4026 Fax : +886-2-2396-8513

### 【 Overseas Contact 】

Nick Hsu (ext. 456) E-mail : nick.hsu@mail.pida.org.tw



**LED professional:** Besides the product characteristics there is also the question of support. What kind of support is there, especially in the area of design-in, for engineers?

**Mr. Zaretsky:** We provide local support in each region world-wide, whether it is engineering, quality, marketing, logistics or sales. In Europe there are 20 branches in 14 countries whereby the European headquarters are in Dusseldorf. We support our customers right from the beginning when we help them to conceptualize the products and ensure an easy start or migration, through the development phase all the way to production. Above all that, as an expert of the market we also support our customers with their road map. We offer several lighting specialized GUI software tools free of charge which allow designers to configure our lighting microcontrollers in seconds even if they don't have any experience with Renesas products or microcontrollers. For example, the ApplileEZ lighting development GUI tool automatically generates a pre-compiled C-code, which permits

developers to concentrate on the application level alone, rather than dealing with the low level lighting functions. We also offer other free comprehensive GUI tools for DALI and DMX communications which are used for developing and debugging custom lighting networks.

**LED professional:** Let's touch on a couple of subjects that concern the future. In your opinion, what can we expect from resonant concepts for LED drivers?

**Mr. Zaretsky:** Indeed, we are observing a gradual increase in utilizing resonant principles in LED driver development. On the other hand, there is only a limited number of clients we have come across who are exclusively using that topology. Within the next two to three years, this type of topology could be increasingly developed. It must be taken into consideration, however, that those resonant circuits are the type of topology which, up until now, have been derived from fluorescent ballasts, and this may result in higher system

costs. The components required for implementing the resonant structure may include a half-bridge, a more complicated transformer, a big output capacitor and a rectification circuit as well as some additional resources which would make the system more expensive, even though a higher efficiency can be achieved.

**LED professional:** How do you see the trend towards the high voltage application of LEDs?

**Mr. Zaretsky:** Systems that exceed 48V require compliance with high voltage regulations in Europe. We believe the market trend is towards the drivers which operate directly from a mains power supply. Since lighting ballasts that are rated above 25W require Power Factor Correction, the integrated PFC controller function in the RL78/I1A is very beneficial in terms of saving system cost and space. The requirement of higher voltages on the output, though, will depend on the application and on the specific customer designs, which could vary greatly. There are always trade-offs

that need to be made between efficiency, number of LED channels and voltage limitations which are up to the customer to judge. We are confident that our solutions for lighting provide a high level of flexibility and thus a wide range of requirements can be supported.

**LED professional:** What does the future of your LED lighting microcontroller products look like? What can you announce to our readers for the coming year?

**Mr. Zaretsky:** We are committed to continue providing dedicated ASSP solutions for intelligent lighting systems implementing integrated features to allow low power, low BOM cost and high intelligence and performance.

We are continuously working on innovative process technology which enables higher integration at lower cost while keeping high performance and low power consumption. We work closely with the relevant standard organizations and government bodies on implementing enhanced communication functions on chip and contributing to high system efficiency by bringing to market a unique internal configuration and dedicated support.

**LED professional:** You just mentioned a very interesting topic. At the LpS 2011, the company, e:lumix presented a concept like that. Are you confirming that the efficiency of an LED can be increased using a special drive-algorithm?

**Mr. Zaretsky:** We are still working on it, assuming that the efficiency can be increased by using a special design of the driving electronics and software. We believe the future of lighting is intelligent LED drivers which will provide communications, support sensors, fine dimming, enhanced controls and feedback. We observe an increased demand for higher CRI (Color Rendering Index) and a higher accuracy in CCT (Correlated Color Temperature) control as well as auto detection and compensation for LED degradation and elimination of the binning effect which can all be

implemented using our single chip solutions for this market. Quality drivers are very important for the LED market. There is not much you can do with a powerful LED chip without a proper driver for it.

I would also like to mention that decent drivers for OLEDs are missing from the industry. Actually, this subject should not be neglected because right now, OLEDs are struggling with their lifetime and brightness. Again, we believe that this can be improved by clever driving electronics and software.

**LED professional:** LEDs are all constructed differently. Does this principle work generally or does this procedure have to be adapted specifically?

**Mr. Zaretsky:** Different LEDs will act differently. We are working on a solution which will allow monitoring the behavior of different LEDs and determine the product and its parameters automatically in order to help the customers to overcome the difficulties encountered when designing LED drivers.

In the area of LEDs and OLEDs we are working on compensating for the degradation in the lumen output over the life cycle as well as on fine PWM control allowing low levels of dimming and accurate color mixing. Long life is one of the greatest benefits of LEDs but it becomes useless if the driver does not support it. It is quite important criteria, especially for applications which choose adopting LEDs mainly because of their longevity, like street lighting and aviation lighting, where maintenance costs are significant.

**LED professional:** That was a very interesting talk, Mr. Zaretsky. Thank you very much!

**Mr. Zaretsky:** Thank you for the interview. ■



### Alex Zaretsky

Alex Zaretsky spent 7 years at Embedded Systems, working on the development of variety of medical and industrial applications. In 2007 he joined NEC Electronics (now Renesas Electronics) and worked as a Senior Applications Engineer for lighting. In 2009, he was promoted to Marketing. Since then, he runs all major lighting segment activities at Renesas Electronics, Europe. This also includes defining the roadmap for Renesas dedicated lighting products and the strategy for the key lighting accounts. Mr. Zaretsky has authored more than 15 marketing and technical publications and is an active member of the DALI consortium. Furthermore, he works closely with other known lighting industry organizations.

# Fundamentals of Planar Remote Phosphor LEDs

Planar remote phosphor LEDs are becoming very attractive for many lighting systems due to their uniform output light distribution and their slim appearance. Dr. Yosi Shani, CTO of Oree, explains this proprietary technology and its advantages for several LED lighting applications.

A remote phosphor configuration is already common. However, with a planar configuration the remote phosphor's benefits can be maximized. The light can be recycled at the output region, thus avoiding any back reflection on the absorbing LEDs, and the phosphor layer can be located far away from the warm LED, thus enhancing the phosphor efficiency by keeping it cold. The fundamentals of obtaining the utmost performance out of these Planar Remote Phosphor LEDs are reviewed herein.

## Introduction

Light Emitting Diodes (LEDs) are taking their first steps toward dominating the illumination market, as evidenced by the first LED bulbs, which are now commercially available, although still expensive. According to market research, LED-based illuminators - which are now only 7% of the market - will be 64% of the total lighting market by the year 2020 (Figure 1).

This expected increase in market share is the result of the advantages of LEDs as a source of light over incandescent bulbs, fluorescent lamps and other competing technologies – advantages that were continuously achieved through the years. Such a continuous improvement in performance is shown in Figure 2, which demonstrates the improvement in LEDs efficacy over the years in comparison to existing competing technologies.

From Figure 2 one may get the wrong impression that LEDs started their commercial journey only recently, where their efficacy was high enough to overcome market penetration issues. However, years ago LEDs were recognized for their long lifespan and their high efficacy as a single color light source. As a result, LEDs were already commercially available years ago, even when their efficacy was somewhat lower. At that time they were used especially in applications where the replacement cost was very significant and in places, like traffic lights, where their efficacy advantage was significant – in which colored output light was required. LED is a natural single color emitter, thus overcoming the need for producing white light followed by optical filters for getting a single color – a process which is very wasteful because 2/3 of the light energy is lost.

The market penetration of color LEDs was impressive, but that alone would not lead to market domination - the main market is in white lighting. White light can be achieved by mixing red, green and blue LEDs. However, with

the LEDs available today, the efficacy of this approach is limited. In addition, in order to get usable white light; i.e. white light with high CRI (Color Rendering Index), at least another LED color must be added, thus making this approach even less attractive. A more efficient way is to use blue LEDs combined with a photoluminescence ("Phosphor") material. In that way most of the blue light is converted to yellow light and the combination of the (remaining) blue + (converted) yellow lights gives white light output with high CRI and high efficacy. Using this approach, highest efficacy records were reported and even higher records are expected (Figure 2).

The conventional way of producing Phosphor-based white LEDs is by covering the blue LED with Phosphor material by bringing the Phosphor in direct contact with the LED die (Figure 3a). The drawback of this configuration is its relatively low efficiency – (i) at operation, the LED gets to be very warm thus heating the temperature-sensitive Phosphor and therefore decreasing its efficiency; (ii) in this configuration a significant amount of the light is reflected back from the Phosphor towards the LED and absorbed there. The way to overcome these issues was to move the Phosphor away from the LED – to build a Remote Phosphor LED configuration (Figure 3b). In this way the Phosphor is heated less by the LED and most of the reflected light is recycled without reaching the absorbing LED die. Some of the first LED bulb manufacturers took this approach even further and

**Figure 1:** General lighting market by technology (from McKinsey Global Lighting Market Model; McKinsey Global Lighting Professionals & Consumer Survey; SILE 2011)

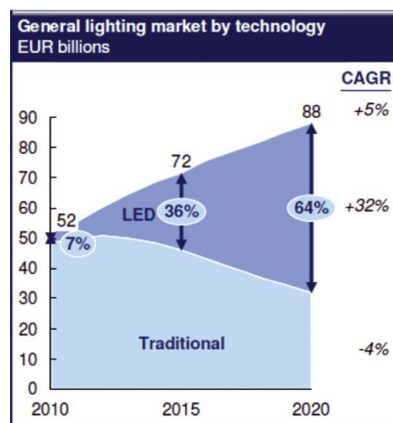

**Figure 2:**  
LED white light efficacy projection (from Cree LpS 2011)

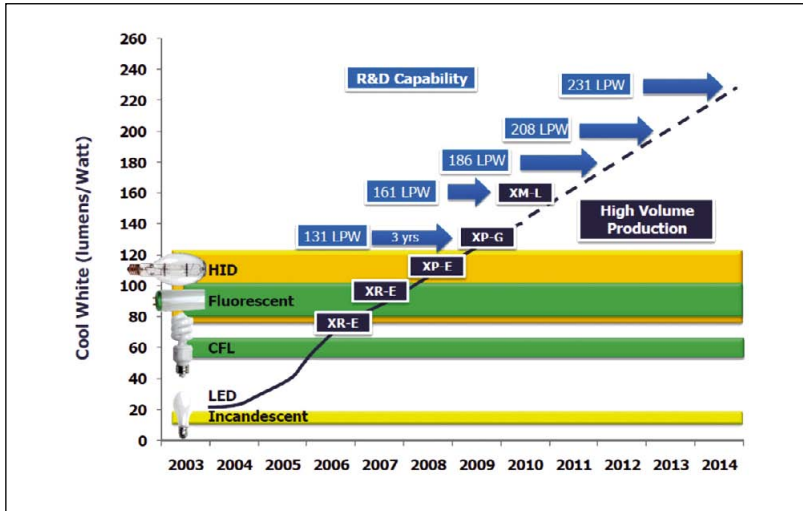

However, due to their small size they can offer much more than that. They can enable slim fixtures, thus paving the way to more space-saving illumination systems and decorative fixtures – the future lighting era.

Combining both – the desire for slim fixtures and the advantages of the Remote Phosphor configuration – led to the development of the Planar Remote Phosphor Module (PRP-module). In the module, LED light is coupled with a panel (a waveguide) and the light is coupled out perpendicular to the panel through a remote Phosphor layer (Figure 4b).

**Figure 3:**  
a) Conventional White LED - a picture and a schematic cross-section  
b) Remote Phosphor LED - a picture and a schematic cross-section

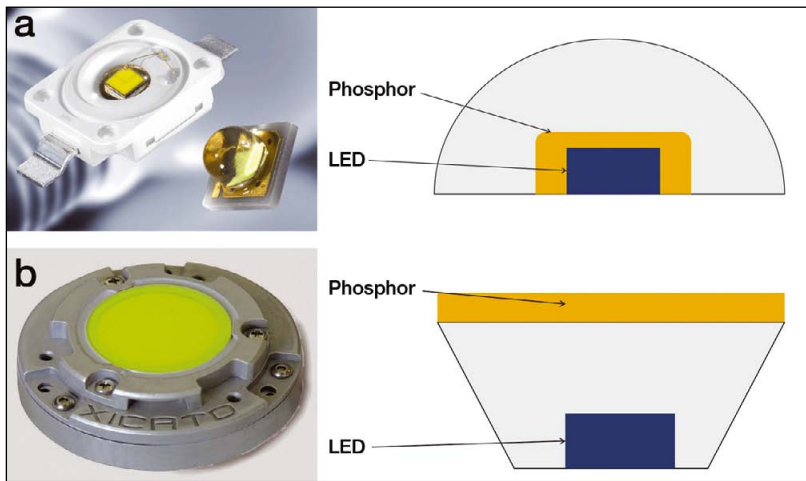

Planar Remote Phosphor is not the only available technology for producing slim illuminating surfaces. Uniformly illuminating LED-based surfaces can be achieved, for example, by placing LEDs in a light box in which its output is covered by a diffuser. However, this technology cannot be considered slim since, in order to achieve acceptable uniformity, the gap between the LEDs and the diffuser is quite significant. The result is a fixture in which its thickness is commonly measured in many centimeters – not slim at all. By comparison, the thickness of the PRP-module shown in Figure 4b is only 5.3 mm.

located the Phosphor much further away from the LED; i.e. located it at the surface of the bulb (Figure 4a). In this way high performance LED bulbs have been obtained, thus paving the way to the major illumination market.

**LEDs as light source offer:**

- (a) long lifetime,
- (b) high efficiency / low power consumption,
- (c) “Green” / no mercury,
- (d) low cost (in the near future) and more.

In another technology, the “White LED edge coupling,” White LEDs are coupled with a waveguide and the light is coupled out through the waveguide top facet. However, within this technology the remote Phosphor concept is degenerated back to a Phosphor layer, which is in contact or only slightly removed from the LED. In order to achieve a more significant remote distance, the LED’s output surface should also be significantly increased (Figure 3b). This increase in the LED’s width must be accommodated with a significant increase in waveguide thickness or with a decrease in (coupling) efficiency; neither are acceptable solutions. In addition, abandoning most of the Planar Remote Phosphor’s benefits result in an inferior product, as is further discussed in the following sections.

**Figure 4:**  
Philips Master LED bulb (left)  
Oree’s White LightCell™ (right)



**Figure 5:**  
A schematic cross section of a planar remote Phosphor LED

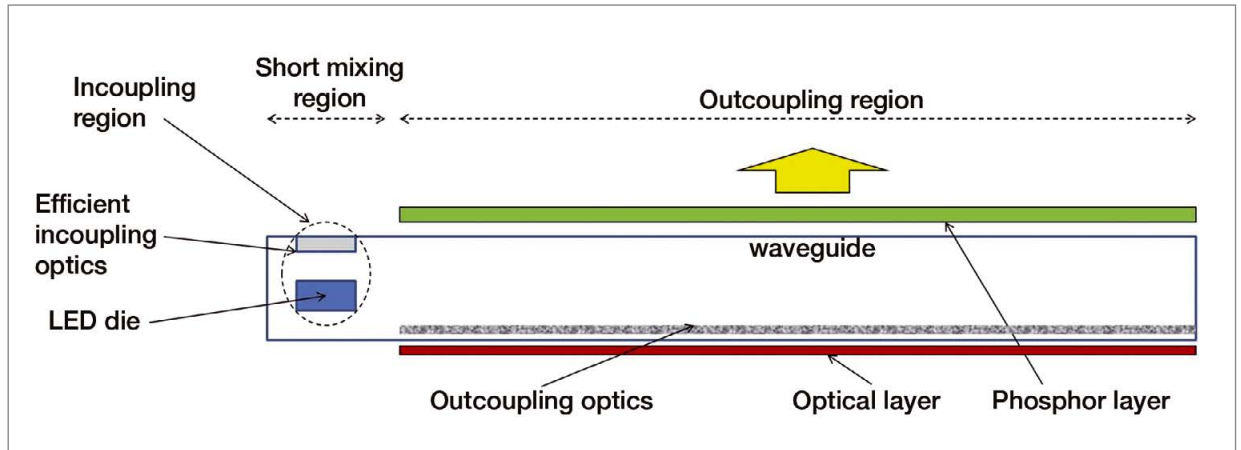

The third competing technology is the future promise of OLED (Organic LED) technology, which is supposed to be even thinner than the PRP-modules. The OLED technology was presented years ago and it made a strong impression on fixture designers, thus, it is expected that the OLED, together with the PRP-module, will open a new era in decorative lighting. However, unlike the OLED, which is continuously delayed (market penetration is expected within 3-5 years) due to cost, performance and reliability issues, the PRP-module technology, which combines three mature technologies: LEDs, waveguides and phosphor, is already commercially available.

### Planar Remote Phosphor Technology

The PRP-module is a planar illuminating LED (Figure 4b), with a schematic cross section as shown in Figure 5. Preferably, the PRP-module is made out of a phosphor layer and a waveguide which consists of three regions: (i) in-coupling, (ii) mixing and (iii) out-coupling regions. Light emitted from the LED is coupled to the waveguide, at the in-coupling region via the in-coupling optics, and is propagating inside the waveguide by means of Total Internal Reflection (TIR). In this way (TIR conditions), the propagating light's loss is minimal and is mainly a function of the waveguide's material loss, which is in most practical cases low since a low loss polymer is commonly used. The mixing region is a short waveguide region in which the light has multiple reflections in order to populate the entire waveguide cross section before it reaches the

out-coupling region. At the output region the light is coupled out via optical elements to obtain uniform out-coupled light distribution. The phosphor layer is located above the output region, thus far away from the in-coupling region in which the hot LEDs are placed. The phosphor layer converts most of the blue LED light to yellow light. Since some of this light is reflected back to the waveguide, a bottom reflecting optical layer is placed at the bottom of the waveguide in order to back reflect it toward the phosphor layer. This bottom reflector layer is commonly placed outside the waveguide in order not to ruin the TIR condition – in order not to increase the propagating loss. A white output light is obtained by the combination of the converted (yellow) and non-converted (blue) lights. The advantages of the configuration described above can be seen in figure 5 and are explained in detail as follows:

- As can be seen in Figure 5, at the output region, the bottom reflecting layer, together with the top Phosphor layer, creates an optical resonator. This optical resonator has a very low loss since (i) the distance between them is small, (ii) the waveguide is made out of low loss material, (iii) there are no absorbing elements (like LEDs, for example) in this region and (iv) the bottom optic layer reflectivity is very high. Thus, most of the reflected rays from the phosphor layer eventually find their way, through the phosphor layer, to the output.

A typical measure of this feature is the “conversion efficiency” – which measures how much of the blue light

is converted to white light. A typical Phosphor LED and a Remote Phosphor LED have conversion efficiencies of 55% and 65%, respectively. While with a PRP-Module, as measured with the White Light Cell, a conversion efficiency of 78% is obtained.

- Due to the PRP-module's large (lateral) dimensions (relative to the LED), most of the Phosphor layer is located far away from the heating hot LED, thus for most practical use the Phosphor layer is actually kept at room temperature. This claim can be seen in Figure 6, in which the simulated thermal distribution of the White LightCell, is shown. As can be seen, most of the output region of the waveguide is at room temperature, ensuring that the phosphor layer above is not exposed to higher temperatures. Now, since the phosphor performance decreases at higher temperatures - with the Planar Remote Phosphor configuration one can obtain the maximum phosphor efficiency available (without going into active or passive cooling methods).

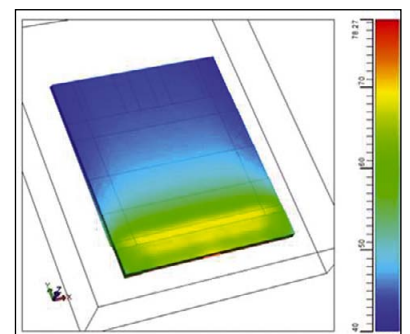

**Figure 6:** Simulated thermal distribution of the PRP-module, at an ambient temperature of 40°C

- As already discussed, slim illuminating surfaces can also be achieved by coupling white LEDs to waveguide, which has optical elements at the output for coupling out the light. However, these configurations suffer from a very non-Lambertian output light distribution. Therefore, luminaires built with them must have an additional diffuser layer – resulting in an increase of optical loss (lower efficacy) and cost. The PRP-module, on the contrary, has the diffusive phosphor layer over its output region and therefore avoids the need for extra optics at the fixture level. A typical PRP-Module light distribution is shown in Figure 7.

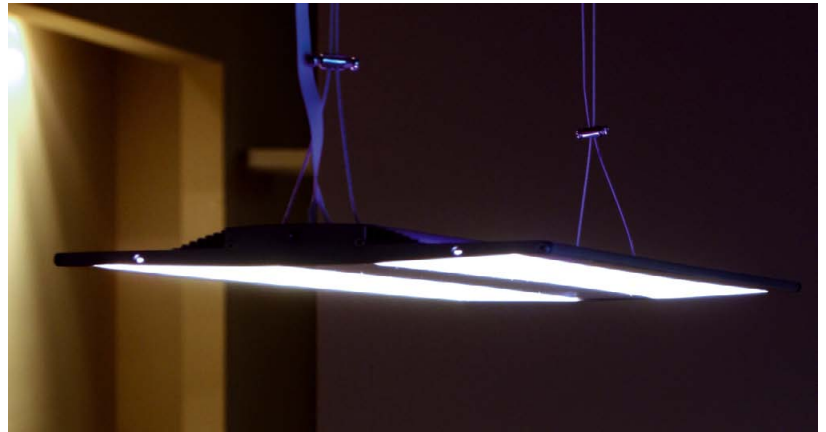
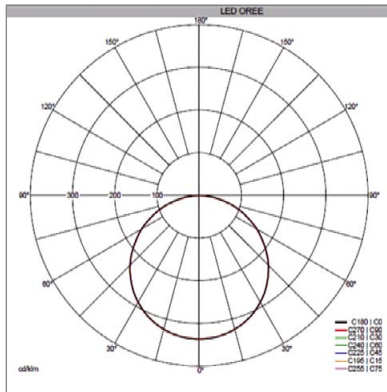

Figure 9: A decorative luminaire based on sixteen White LightCells

Figure 7: The White LightCell output light distribution



- One of the major advantages of the PRP-Module is its uniform output light distribution. In contradiction to a common LED which is a point source, with the PRP-Module, planar uniform illuminating panels can be obtained without the need to sacrifice thickness (which is the common solution with conventional LEDs for obtaining large uniform

illuminating surfaces). Excellent uniformity is a function of the out-coupling optics, which is commonly based on optical structures, and due to the recycle region at the output region which removes non-uniformities. An example of an achievable uniformity is depicted in Figure 8 in which picture and plots of the measured the PRP-module output light uniformity are shown.

Another advantage of this available uniform PRP-module output light distribution is its ability to be a building block for fabricating large, slim illuminating panels. For that purpose, the PRP-modules can be arranged side by side or in a tiling configuration, in which an output region of one PRP-module covers the non-emitting (mixing) region of the other PRP-module. An example for a decorative slim luminaire, built using 16 White LightCells is shown in Figure 9.

### Conclusions

Planar remote phosphor LEDs are superior over competing technologies as building blocks for fabricating slim, decorative illuminating systems in which uniform output light distribution and slim appearance are important. Planar Remote Phosphor technology is based on the already mature LED, phosphor and waveguide technologies. As a result, by combining these three technologies, a superior, already mature, product is achieved which extracts the farthest of the remote phosphor LED concept capabilities. In Planar Remote Phosphor LED configuration, the light is recycled away from the LED, thus avoiding any reflection to the absorbing LEDs, and keeping the temperature-sensitive phosphor layer away from the hot LED, thus enhancing the phosphor and system efficiency. ■

Figure 8: The PRP-module output light uniformity – (a) top view, (b) and (c) lateral and longitudinal intensity distributions, respectively

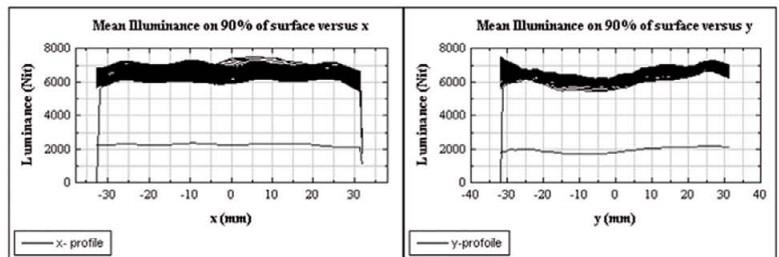

# Silicon Integrated Passive Device Technology for LED Applications

One general trend in electronics is the integration of components and functions in one single integrated circuit. Laurent Dubos, Market Segment Director for Lighting at IPDiA, shows that not only active components can be part of an IC, but also several passive components can be integrated. He demonstrates that besides space savings, quality issues are also a hot topic that need to be looked at and are a reason to use this technology.

An LED driver is a power supply that matches the voltage and the current output to the electrical characteristics of an LED or array of LEDs. From an environmental point of view, some of the applications of these HB-LED modules are very demanding, with some specific constraints about the space requirements in the bulb replacement market. These harsh constraints are getting even worse due to the thermal behavior of those HB-LEDs. More than 80% of the power has to be dissipated by conduction where ambient temperatures are very high around the power supply electronic module.

High reliability of the HB-LED that can last at least 50,000 hours is strongly jeopardized by the low reliability of the passive components surrounding the driver. The reliability of the capacitor as well as the mechanical stresses of handling and soldering passive SMD components on the electronic module is seen as the Achilles' heel of these modules.

The Integrated Passive Device technology can solve most of the issues encountered by Solid State Lighting Module designers.

## Integrated Passive Device Definition

IPD technology (Integrated Passive Device) on silicon are a highly efficient way to integrate several passive components such as resistors, capacitors, inductors, ESD diodes and PIN diodes in a single die. The main benefits of this technology are miniaturization as well as reliability and global manufacturing cost

reduction. The level of technology required to manufacture those Silicon Passive component arrays is the same as the one required for manufacturing CMOS die. It is important to note that the fabrication of silicon passive arrays only require standard semiconductor process techniques and the materials used are well known and appreciated for their high reliability.

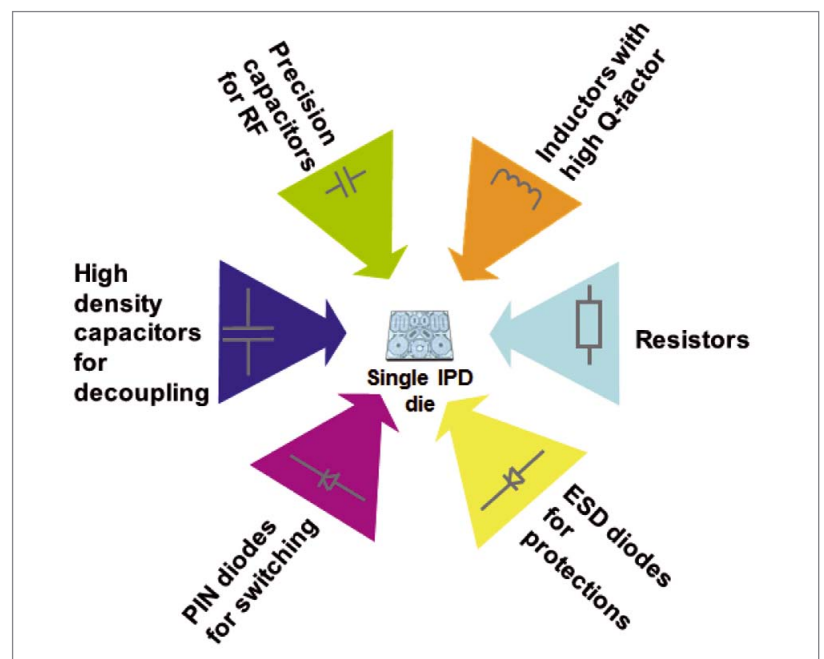

**Figure 1:** IPDiA, IPD (Integrated Passive Device) provider is focusing its activities on 3D passive integration in silicon with an advanced technology called "PICS" (Passive Integrated Connecting Substrate). High-density trench capacitors, MIM capacitors, resistors, high-Q inductors, PIN diodes or zener diodes are implemented in silicon allowing their integration in various packaging technologies



### Performances and Advantages of Silicon Passive High Density Capacitors

This Passive Integrated Connecting Substrate (“PICS”) technology exhibits inherent good performance with very high stability (temperature, voltage, ageing), superior reliability and very low parasitic elements (ESR, ESL). It is an excellent alternative to discrete components (MLCC and tantalum capacitors) as its performance is better in a much smaller volume.

#### Stability

The temperature performance exceeds MLCC and tantalum capacitors, like silicon capacitors, are very stable over the -50°C / +200°C temperature range (<0.002%) (Figure 2). The capacitance

value is also very stable whatever the DC voltage variation applied on the electrodes is, as depicted in Figure 3 (<0.1%/V). There is no trade-off needed between density and stability: “Integrated Passive” technology offers both - unlike MLCC and tantalum components.

#### Reliability

Passive components in an SSL Module can withstand more than 150°C. A standard capacitor can’t support a long life time in this type of environment which means the lifetime of the HB-LED device can be decreased sharply. The main advantage of the capacitor built in a silicon passive array is the amazing reliability that exceeds all current market standards. Silicon capacitors

are able to bear harsh environment conditions such as those encountered in down hole equipment with the temperature going up to 250 °C.

Table 1 depicts a summary of the reliability performances of silicon capacitors compared to X7R capacitors in 3 different application scenarios: Operating voltage and 50% of the operating voltage, at 37°C and 85°C.

Engineers commonly use FIT rates to estimate reliability. FIT rates are expressed in failures per billion piece hours. With FIT rates, we can make reliability predictions at the parts-per-billion and parts-per-million levels into future years of device service given application use conditions. PICS provides a Failure In Time (FIT) rate ten times better than standard

**Figure 2:** Temperature performances comparison with various types of MLCC

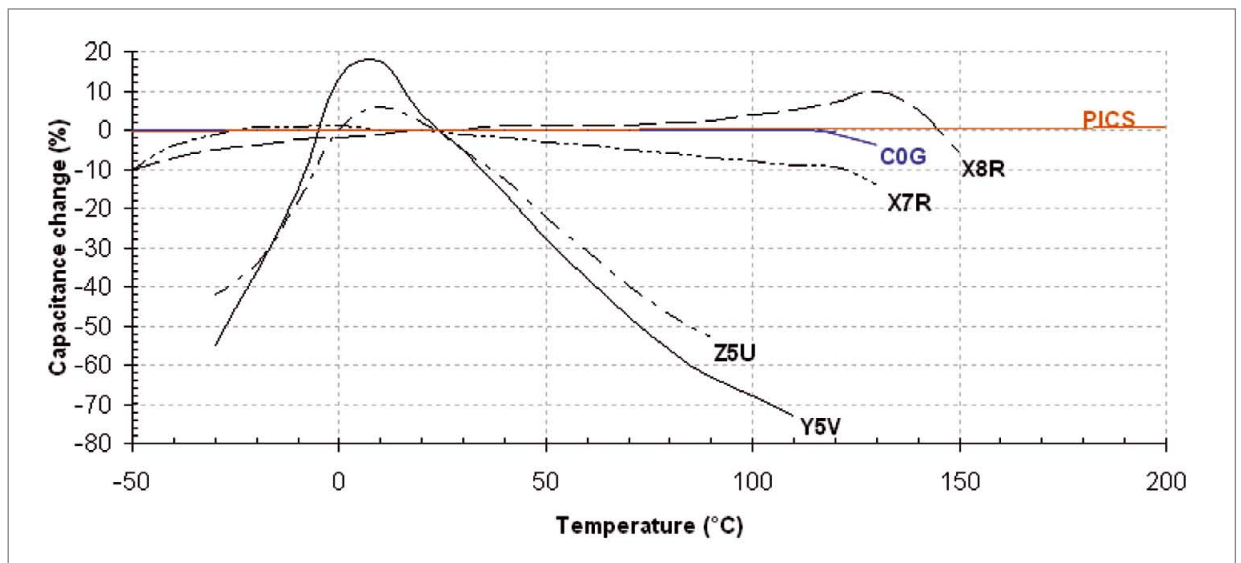

**Figure 3:** Voltage stability performances comparisons with various types of MLCC

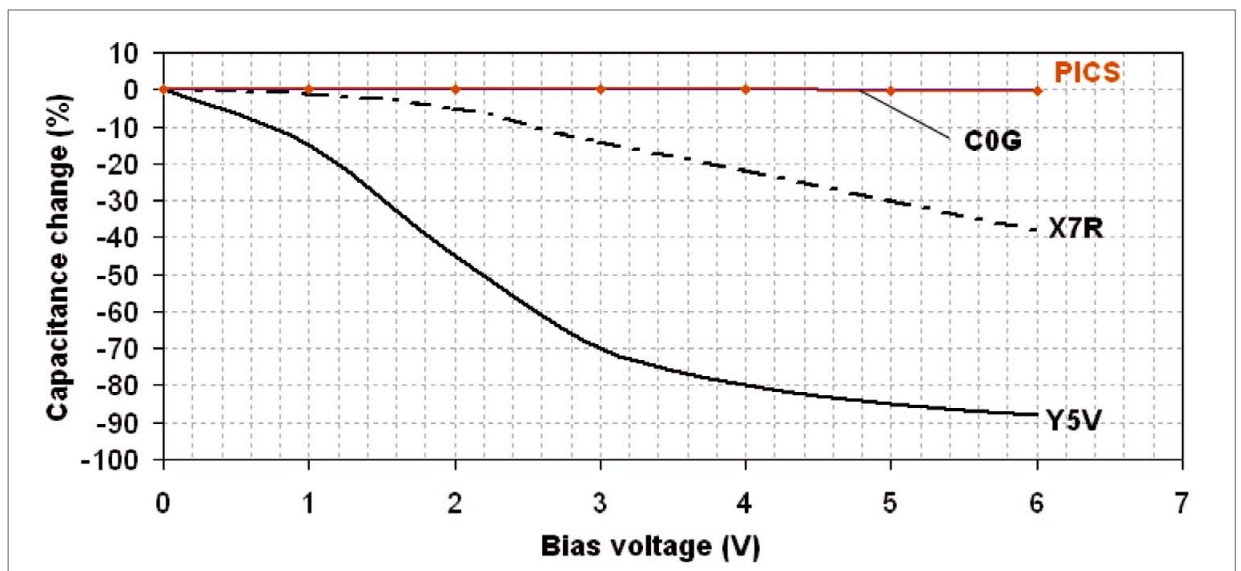

**Table 1:**  
X7R, Silicon capacitor FIT

Capacitor	FIT	FIT	FIT
	V operating 37°C	50% V operating 37°C	50% V operating 85°C
X7R 0402 100 nF	1,31E-01	9,44E-03	2,14E+00
Silicon Capacitor 0402 33 nF	1,25E-02	2,44E-04	4,74E-04

**Table 2:**  
X7, Silicon capacitor Median time to failure

Capacitor	MTTF years	MTTF Years	MTTF years
	V operating 37°C	50% V operating 37°C	50% V operating 85°C
X7R 0402 100 nF	4,40E+04	6,20E+05	2,50E+03
Silicon capacitor 0402 33 nF	4,16E+06	6,99E+07	2,10E+07

**Figure 4:**  
Capacitance stability versus applied voltage at different temperatures

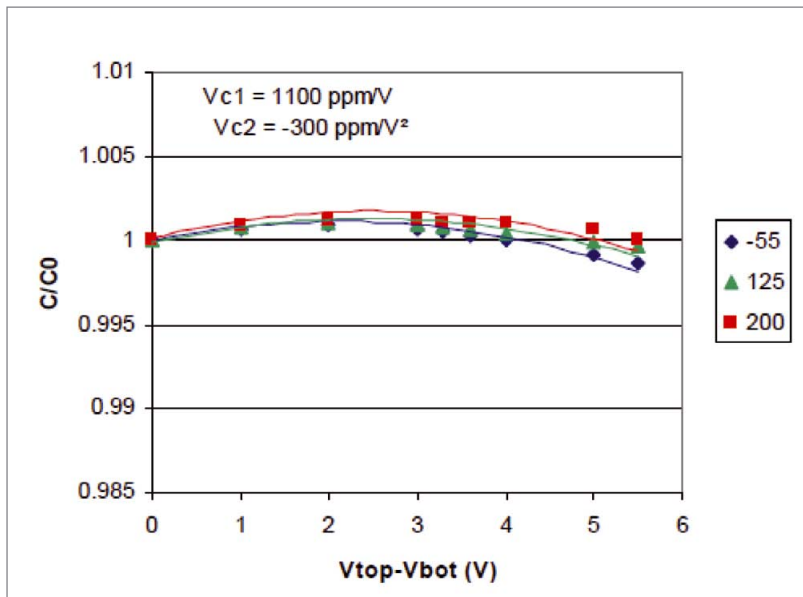

### Silicon Passive Component Applied to Solid State Lighting HB-LED Module

Figure 5 shows a voltage converter board in a solid state lighting refurbishing bulb. The main technical barriers to be solved to improve the efficiency of the module are:

- Decreased components life due to high temperature environment
- Space constraint linked to the existing form factor of SSL module
- Failure and low reliability due to mechanical stresses of handling, soldering and manual assembly (encountered with MLCCs multilayer ceramic capacitors)

**Figure 5:**  
Voltage converter board in Solid State Lighting refurbishing bulb

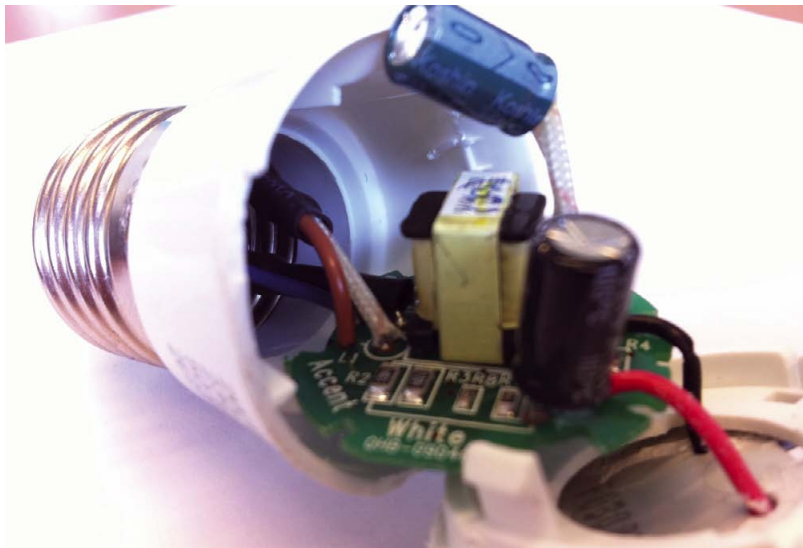

The main benefits of replacing SMD's passive components by a silicon passive components array in Solid State Lighting modules are:

- Life time of passive components at the same level of HB-LED
- Tens of passives in one silicon die
- Operating temperature range up to 250°C
- Increased light output power due to miniaturization
- Few solder joints to maintain reliability
- Reduced EMI, thanks to excellent silicon capacitor high frequency response
- 100 μm thickness for SIP (System in Package) integration
- Customized and protected design against copy
- Silicon capacitors are more reliable, more stable in time and temperature than X7R capacitors

SMD @ 37°C and 10,000 times better @ 85°C. This performance demonstrates the robust reliability of the silicon component.

The projected median time-to-failure is well in excess of 2,000,000 years for SSL devices using the silicon capacitors at the operating voltage and 85°C (Table 2).

### Charge Pump Aspects

In charge pump applications, one parameter is critical: the next Figure shows the stability of the capacitor value (C) compared with the value when no voltage is applied (C0) for various supply voltages and temperatures.

**Figure 6:**  
Input schematic

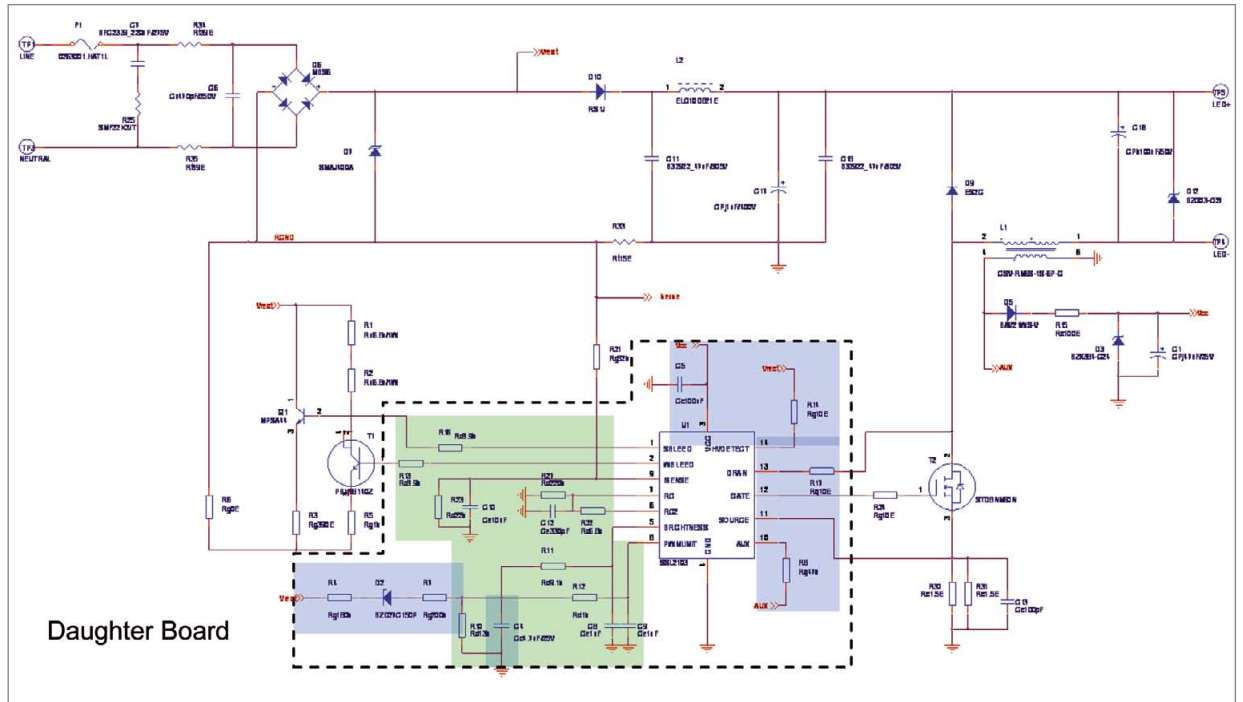

**Figure 7:**  
Assembly for scenario 1

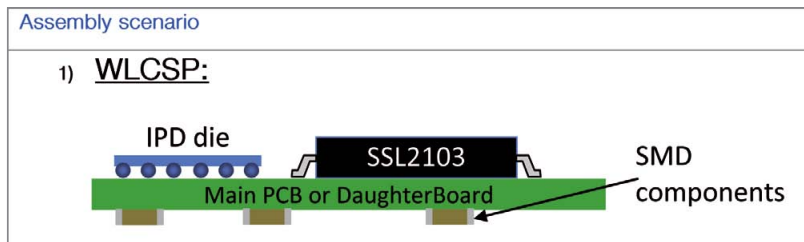

**Example of a realization based on LED Driver**

In this example we propose 2 scenarios to demonstrate the efficiency of the integration of silicon passive devices in a Solid State Lighting module.

**Table 3:**  
Lists of the passive components to be integrated

DIE #	Components to integrate	Estimated area with SMD components (mm <sup>2</sup> )	Estimated area with IPD (mm <sup>2</sup> )	Area saving (mm <sup>2</sup> )	Number of pads on the IPD
1	R13, R16, R23, R27, R22, R11, R12, R10, C10, C12, C8, C9, C4	14.4 (0402 chips)	5 (3 x 1.7 mm)	9.4	11 (bumps)

**Scenario 1: Passive Component Array**

This first case shows the integration of all the components selected in the green areas (schematic above) in a silicon passive component array (IPD) reported on the SSL PCB.

**Figure 8:**  
Schematic, pinning table and top view of the IPD die for scenario 1

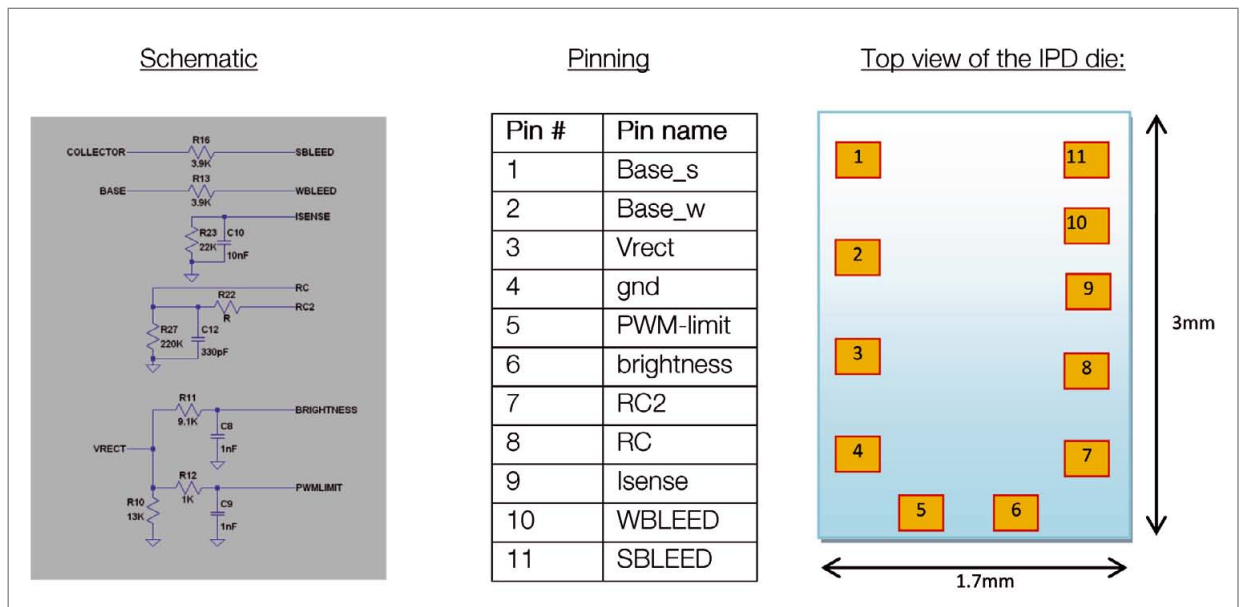

**Figure 9:**  
Two possible assemblies for scenario 2

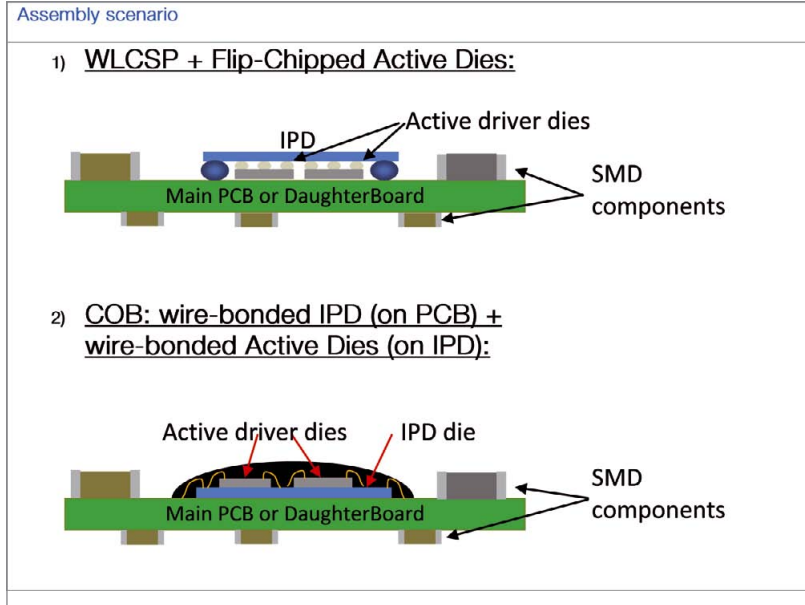

**Scenario 2: Silicon Interposer**

In this scenario all the components selected in the green areas (input schematic above) are integrated in a silicon interposer on which the two dies of the driver are flip-chipped. The implemented device can be soldered onto the board of the SSL module.

One more scenario would be to include the IPD die together with the active dies in the SO14 package.

In this example, the key benefits of such a solution are:

- Good area saving: around 58 mm<sup>2</sup> for the second scenario
- Only one component to place instead of 13 SMD's
- The design is customized and well protected against copy
- IPD capacitor solutions are more reliable, more stable in time and temperature than X7R capacitors

Table 6 shows the different scenarios.

**Table 4:**  
The IPD includes these passive components

DIE #	Components to integrate	Estimated area with SMD components (mm <sup>2</sup> )	Estimated area with IPD (mm <sup>2</sup> )	Area saving (mm <sup>2</sup> )	Number of pads on the IPD
1	R13, R16, R23, R27, R22, R11, R12, R10, C10, C12, C8, C9, C4, U1	68.65 (0402 chips + SO14)	10.15 (2.9 x 3.5 mm)	58.5	11 (bumps) connections IPD/PCB

**Figure 10:**  
Schematic, pinning table and bottom view of the IPD die for scenario 2

Schematic

Pinning

Pin #	Pin name
1	Base_S
2	Base_W
3	Vcc
4	gnd
5	Vrect
6	gnd
7	Isense
8	AUX
9	SOURCE
10	GATE
11	DRAIN
12	HV-Detect

Bottom view of the IPD die:

**Table 5:**  
Connections between active driver dies and IPD and connections between IPD and PCB

	Dimensions	Pad size	Ball diameter	Ball height	Min. pitch	# of bumps
<b>Connections Active driver dies / IPD:</b>						
DIE 1	1.83mm x 1.33mm	70 x 70µm	TBD	TBD	95µm	12
DIE 2	1.83mm x 0.98mm	90 x 90µm	TBD	TBD	120µm	13
<b>Connections IPD / PCB:</b>						
IPD	2.9mm x 3.5mm	230µm	300µm	260µm	750µm	11

**Table 6:**  
Space requirements of the different solutions discussed

Scenario	Configuration	Total area (mm <sup>2</sup> )	Die area (mm <sup>2</sup> )
0	SMD components + SO14	68	none
1	Passive component Array + SO14	60	5
2	Silicon Interposer	10	10
3	SIP (3 dies into SO14)	55	5

**Figure 11:**  
Size comparison between the original PCB layout and the equivalent IPD solution

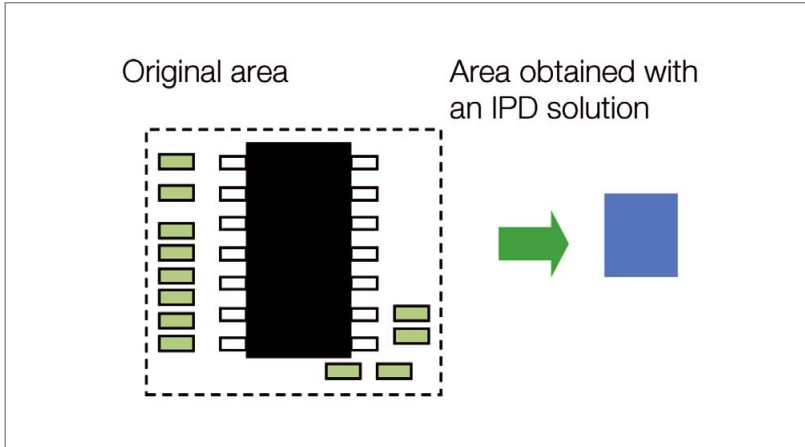

**Figure 12:**  
Other example of integration combining silicon integrated passive technology with LED dies

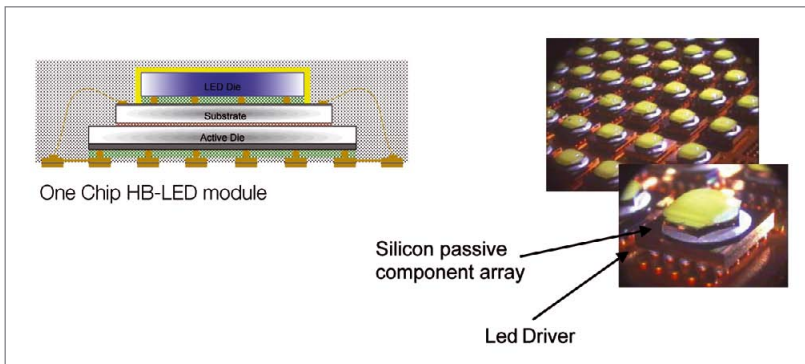

### Conclusions - A Brilliant Future

The Integrated Passive Device technology has been used in the market place since the beginning of the HB-LEDs packaging history. The capability of providing both platforms for integration and embedded ESD protection was considered as an alternative solution to ceramic based platforms requiring additional pick and place for the protection of the Zener.

The direction of the silicon passive IPD manufacturer is clear. They must optimize the components to fit the requirements of the SSL module. Some of the major challenges that they are facing are the integration of inductors with a couple of  $\mu\text{H}$ , as well as capacitors with several  $\mu\text{F}$  in the silicon.

Other areas of development to be considered are the convertor switching frequency increase up to 100 MHz, combined with the higher performance of the silicon passive components

Some big players in the market place have already demonstrated the capability of designing a one chip solution DC converter, based on integrated passive devices. ■

# Polycarbonate Leads in LED Applications

Polycarbonate (PC), polymethyl methacrylate (PMMA) and, to a lesser extent, glass, have traditionally been chosen for LED optical applications. Bala Ambravan, Global Product Marketing Director of SABIC, compares these optical materials and explains why polycarbonates are the first choice for most LED lighting applications.

Technological advancements in light-emitting diodes (LEDs), such as higher lumen output and longer life spans, together with their expansion into the huge general lighting market (LEDs are estimated to capture a 43% share of that sector by 2016 and 64% by 2020 [1]), have accelerated the use of polycarbonate (PC) resins in various optical applications for LEDs such as lenses, covers, tubes, pipes, diffusers and reflectors.

LED technology is rapidly changing to meet market demands for higher brightness, improved aesthetics, lower costs and longer useful life. These trends have raised concerns about components of LED lighting fixtures. One issue is how to increase the durability of these components to match the exceptional – and growing – life span of the LED modules themselves. Another is improving

luminous efficacy (using less energy to achieve the same brightness), which is being addressed in part by increasing the light transmission performance of optical lenses and covers. Still another challenge is enhancing the quality of LED light for residential applications (making it softer and closer to incandescent lighting and avoiding hot spots) to drive consumer adoption. Finally, because LED costs remain comparatively high, it is important to protect these expensive modules with impact-resistant components.

New PC technologies like SABIC's improved-clarity PC technology offer potential solutions to all these issues. Although polymethyl methacrylate (PMMA) and, to a lesser extent, glass, have traditionally been chosen for LED optical applications, both materials have drawbacks that these new PC materials avoid. Further, as LEDs continue to evolve and raise the bar on requirements for optical components,

the high-performance attributes of PC easily accommodate new demands – higher temperature ranges and longer exposure to heat, tougher flammability requirements and new designs (Figure 1).

Overall, improved clarity PC technology provides a comprehensive value proposition to meet current and future requirements from molders, manufacturers and regulators. This benefits package includes exceptional mechanical properties and durability; light transmission on par with PMMA, freedom to design and mold innovative configurations and build in specific diffusion levels; and most critically, compliance with safety and sustainability mandates.

These next-generation PC resins are engineered with improved monomers and are produced using an innovative, technologically advanced process. This results in high-purity resins that provide significantly improved light transmission as molded and after heat aging, as compared to “standard” and “optical grade” PCs, as well as other performance enhancements. Improved-clarity resins are helping to drive the growing prominence of PC in the LED market, particularly the general and automotive lighting sectors.

Following are the major advantages of improved-clarity PCs over traditional acrylics and glass for LED optical components (Figure 2).

**Figure 1:** Improvements in polycarbonate from standard PC to Improved Clarity PC when positioned for LED applications. Superior optical properties (as molded and post aging – thermal and UV) with lower Yellowness Index is desirable

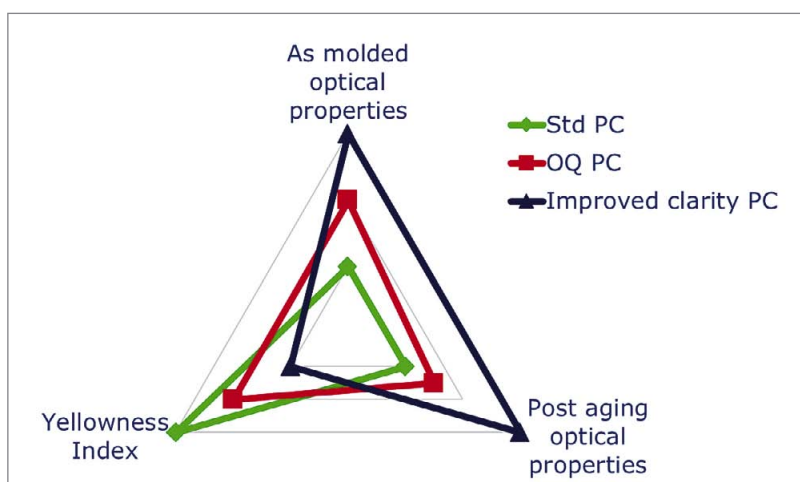

**Figure 2:** Physical and optical properties of glass, PMMA/ acrylic and polycarbonate. Outer portions of the chart have higher desirability for each property

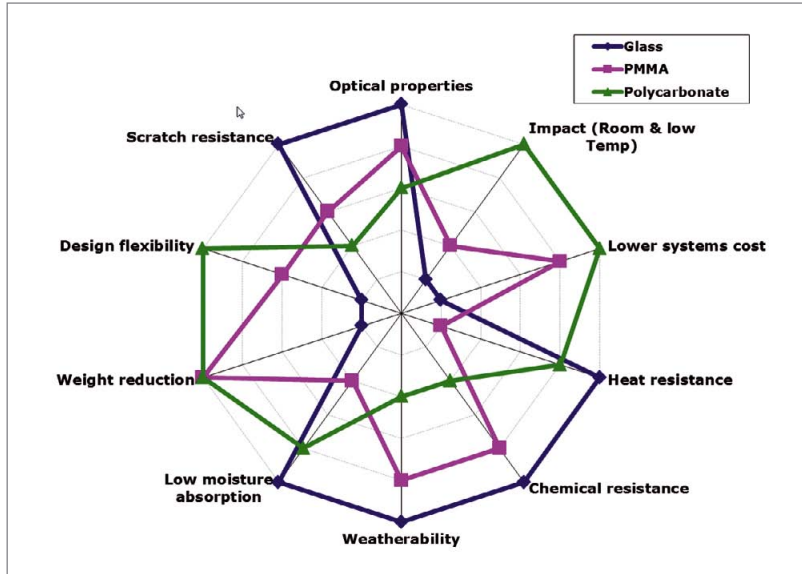

### PC Goes the Distance

One of the chief advantages of LEDs is their extended useful life of >30,000 hours (more than 10-15 years). While this long life span means LEDs are more environmentally responsible and cost-effective than previous types of lighting, it raises concerns about the durability of LED lenses, tubes, reflectors and covers. Will these parts last as long as the LED itself without degrading from exposure to heat and ultraviolet (UV) light? Will covers and lenses effectively protect the expensive LED light source from impact and damage, particularly in residential retrofit applications where consumers handle (and sometimes drop) the replacement lights?

Improved-clarity PC resins provide an array of performance properties that help LED lights operate effectively over their full useful life. First, PC is renowned for outstanding impact resistance that surpasses the performance of PMMA by a factor of 10 in typical lab or practical impact measurements and that of glass by a factor of 30.

Because LEDs are increasingly used for architectural lighting, exterior lighting (e.g., parking lots, streetlamps) and automotive applications, weatherability is critical to optimal light transmission and life span. Depending upon their formulation, improved-clarity PC resins can provide UV/ weatherability resistance according to UL746C with the necessary F1 rating.

Resistance to UV light, which can cause yellowing and embrittlement of polymers, is a major aspect of outdoor exposure; however, even interior LED fixtures must be able to withstand UV radiation from ambient light and sometimes from the source itself. Improved-clarity PC resins offer enhanced anti-yellowing performance to maintain light transmission and resist becoming brittle so they retain their excellent impact properties.

In outdoor lighting, transparent, weatherable PC resins offer a welcome alternative to both glass and PMMA because they combine high impact performance to protect the solid-state LED from vandalism and other threats, meet stringent UL requirements for weatherability and flame retardancy and optimize forward transmission of light. In contrast, breakable glass does not provide sufficient impact protection, and PMMA does not meet UL94 V0 requirements.

Heat aging, another key aspect of LED life span, is becoming even more important as high-brightness LEDs (HB LEDs) with higher lumen outputs place added stress on optical components. Improved-clarity PCs can handle extended exposure to temperatures of 110°C to 130°C, which is a developing trend for HB LEDs, while retaining their mechanical and optical properties.

### PC Strikes the Right Balance

Some LED applications, such as downlights and spotlights for industrial or commercial spaces, call for maximum brightness. Also, designers and manufacturers are looking for ways to reduce LED costs by optimizing brightness while minimizing power consumption. In these cases, it is vital to take full advantage of every lumen produced by the LED module. In contrast, applications such as residential lighting require a uniform, diffuse light that hides hot spots. Covers, lenses, tubes and reflectors used with LED light sources play a crucial role in striking the right balance between transmission and diffusion.

**Figure 3:** Yellowing due to UV exposure is one major problem in outdoor applications. Improved PCs retain their gloss and color stability up to 5 times longer than standards PCs



Improved-clarity PC materials offer high transparency that can provide ~ 90-92 percent light transmission, nearly comparable to that of PMMA. This capability makes them suitable for HB LEDs used to retrofit high-intensity discharge (HID) fixtures and fluorescents, as well as for flashlights and automotive headlamps.

When diffusion is required, specialized PC resins can provide a broad spectrum of light management to customize hiding power levels without compromising forward light transmission (Figure 4). Different diffusion technologies can provide narrow-angle or wide-angle light scattering, while diffusers plus opacifiers combine translucent scattering with wide-angle light scattering. PC manufacturers may be able to tailor diffusion properties to meet customer requirements. Diffusion-based PC products also provide a “system” solution that could be more effective and cheaper than a diffuser film that is often used in such applications.

Specialized anti-dust grades of PC can meet requirements for reflectors used in LED downlight applications. These reflectors need to provide diffused light (rather than specular reflection) and retain their reflective properties over the life of the downlight. Anti-dust capability helps to maintain long-term reflectivity performance. At the same time, although the PC grades are highly filled, they retain their excellent mechanical properties. Finally, the design freedom provided by PC facilitates the creation of diverse reflector shapes. In contrast, anti-dust PMMA materials cannot deliver equivalent mechanical performance and do not meet UL94 V0 flame retardancy requirements.

### PC Takes the Heat

LEDs generate heat that is not fully dissipated by heat sinks. Therefore, materials used for lenses, reflectors and covers in close proximity to the light source must be thermally stable and flame retardant (FR). Heat generation is increasing due to higher brightness of LEDs that require at least 1 W of power or more.

Miniaturization to reduce material costs and meet market demands is also contributing to higher temperatures: not only are LEDs positioned closer to other components, but heat sinks are shrinking due to lack of available space and therefore are less able to dissipate heat.

In fact, typical operating temperatures for HB LEDs are already around 80-90°C, and are expected to go higher by 20-30°C as more powerful modules and smaller form factors are developed. Specialized PC resins address this trend by providing thermal resistance up to 130°C, which represents an improvement of 20-30°C over standard PMMA. Above 110°C, PMMA begins to deform.

As mentioned earlier, improved-clarity PC grades retain their high light transmission and mechanical properties after extended heat aging, even at elevated temperatures. Some of the LED replacements for higher wattage incandescent bulbs (e.g. 75 W or 100 W) already require temperature resistance over 120°C.

From a safety perspective, the improved-clarity PC resins provide flame retardancy meeting UL94 V0 down to 1 mm and V2 down to 0.75 mm with high transparency. Although the global safety standards for LED lighting are still evolving (UL in the United States, IEC in Europe and in Asia, UL, IEC or specific local standards), PC provides a higher ceiling in FR and thermal resistance performance to accommodate evolving regulations. In contrast, PMMA does not meet these UL standards (it complies with the UL94 horizontal burn rating only).

In addition to compliance with safety standards, these clear, flame-retardant PCs use FR technology that supports environmental directives. By avoiding bromines, chlorines and phosphates, these materials comply with eco labels and regulations such as the European Union’s Restriction of Hazardous Substances (RoHS) directive.

**Figure 4:**  
A typical A19 retrofit light bulb mostly uses a light diffusing PC cover





**Figure 5:**  
Modern plastics are not only useful for optics, they can also be tuned for excellent heat management like the LNP\* Konduit\* (white) used in the Leedarson Candle Bulb



### PC Expands Design Freedom

The general lighting industry is fragmented and complex. According to McKinsey & Company, “Further complexities are created by the advent of LED. This totally different technology for emitting light is upending the role of the replacement business and transforming the landscape of the lighting industry value chain entirely [1]. The diversity of the market is creating the need for versatile materials that combine high performance with attractive aesthetics and innovative designs.

LED designs are already far more diverse than those used for incandescent or fluorescent lighting. To address this trend, plastics such as PC offer a choice of processing methods (injection and blow molding, extrusion), molded-in color and the ability to create complex shapes, including part integration. Glass presents significant design limitations in these areas.

When comparing plastic types, PC surpasses PMMA in the breadth of its design window. In particular, PC enables sharp corners and notches that can further accentuate PMMA’s weakness in impact strength. When extruding large diffuser sheets used for wall and ceiling LED applications, PC maintains its impact and rigidity better than PMMA, which tends to sag. Similarly, PC’s dimensional stability, as well as strength and toughness, enable thin-wall molding (ranging from 0.5 mm to 1.0 mm) for cost savings and weight reduction as well as significantly improved light efficiency.

Another benefit of PC is molded-in color capability to enhance LED lighting aesthetics for broader consumer appeal and greater design choice.

One interesting area for LED design innovation is automotive headlamps. LEDs are being used for special lighting enhancements including “angel eyes” accent lights (a halo effect) and strips of small LEDs used for daytime running lights or fog lamps, which have been pioneered by Audi and Mercedes-Benz. Versatile PC resins can contribute high light transmission combined with UV resistance, impact resistance and high heat tolerance to these distinctive designs.

Specialty PC resins have also been engineered with high reflectivity performance. These materials can be used in headlamp reflectors to maximize the luminance of LED modules without the need for secondary coatings or plating. They also offer the opportunity to integrate the reflector into the LED module.

In architectural lighting as well as automotive lighting, PC is an excellent choice for light pipes or tubes, which are used to move light from its source to its destination by channeling it over a few millimeters or up to 100 meters. Light pipes provide design flexibility and eliminate components and assembly steps. PC provides the right balance of optical properties (transmission and refractive index), durability and processability (extrusion or profile) for these applications – particularly long, thin pipes.

### Conclusion

PC is becoming a preferred material for tubes, covers, lenses and reflectors in LED lighting designs. Specialized PC grades have been engineered with a range of desirable performance attributes – from thin-wall capability to exceptional heat aging performance to sustainable FR systems – which build upon the material’s classic impact resistance, toughness and clarity. As LED technology races ahead, new applications are developed, new markets are penetrated and regulations evolve, PC resins provide the variety, performance and versatility to meet these new challenges. ■

### References:

[1] “Lighting the way: Perspectives on the global lighting market,” McKinsey & Company, July 2011.

# Resonant Converter Based LED Drivers

Resonant converters are not new to the lighting industry. They have been used for years in FL or HID lighting ballasts. Peter B. Green, LED Group Manager at International Rectifier, shows that this driver concept also has its advantages in some LED lighting applications and is well worth being considered.

In LED general lighting the resonant converter topology offers several benefits at power levels that range from 50 to 250 W. These include electrical isolation, high efficiency, small magnetics and no electrolytic capacitors at the output. These benefits have been exploited for many years in AC to AC fluorescent and HID lighting ballast designs. However, LED drivers have generally adapted AC to DC switched mode power supply circuit topologies such as; Buck, Boost, Flyback, Cuk, SEPIC etc. to the application.

Resonant converters are rarely used today because they are deemed to be complicated and expensive. But resonant LED drivers and power supplies share the same basic design with some important differences. This consists of a two stage system with a front end power factor correction stage followed by a resonant isolation and

step down stage with a rectifier and filter at the output. The difference is in the control system, where the power supply produces a regulated constant output voltage; the LED driver needs to produce a constant output current.

### System Overview

The front end PFC stage consists of a standard Boost regulator that converts the full wave rectified AC line voltage to a DC bus voltage usually between 400 and 500 V. The DC bus voltage feedback loop responds slowly over many AC line cycles so that the MOSFET on time remains essentially constant during a cycle.

Control ICs do often increase the on time as the AC line cycle approaches a zero crossing to compensate for crossover distortion and reduce THD.

The majority of controllers operate in critical conduction mode (the boundary between continuous and

discontinuous conduction modes) where the off time varies during the AC line cycle producing an approximately sinusoidal AC input current in phase with the voltage. This technique is well known and used in many different applications.

The PFC inductor value can be calculated from the following formula:

$$L_{PFC} = \frac{(VBUS - \sqrt{2} \cdot VAC_{MIN}) \cdot VAC_{MIN}^2 \cdot \eta}{2 \cdot f_{MIN} \cdot P_{OUT} \cdot VBUS} \text{ [Henries]}$$

where

$VBUS$  = DC bus voltage

$VAC_M$  = Minimum RMS AC input voltage

$\eta$  = PFC efficiency (typically 0.95)

$f_{MIN}$  = Minimum PFC switching frequency at minimum AC input voltage

$P_{OUT}$  = System output power

**Figure 1:**  
Resonant power supply topology basic elements

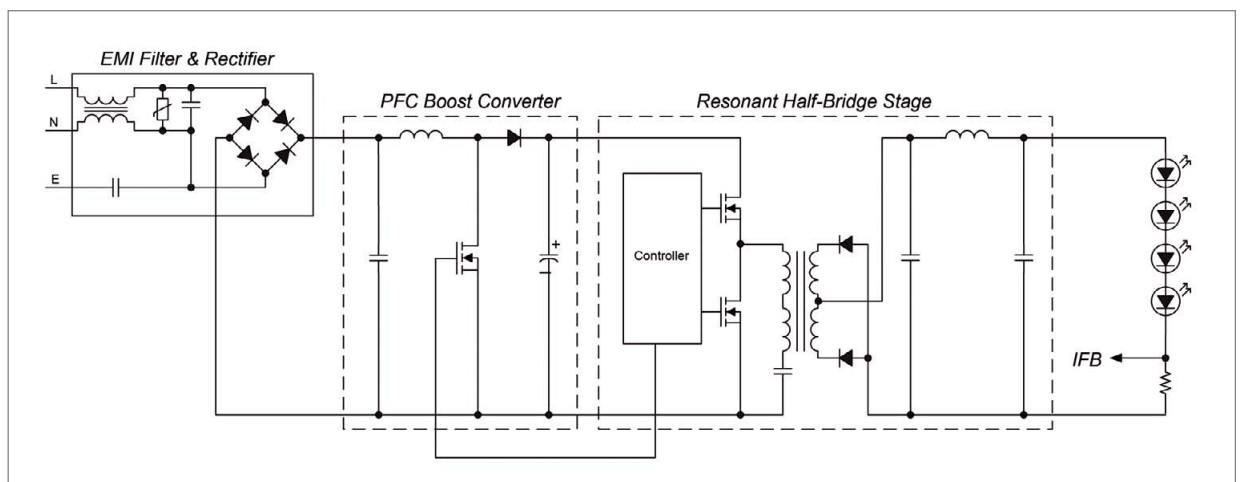

**Figure 2:**  
LLC resonant circuit

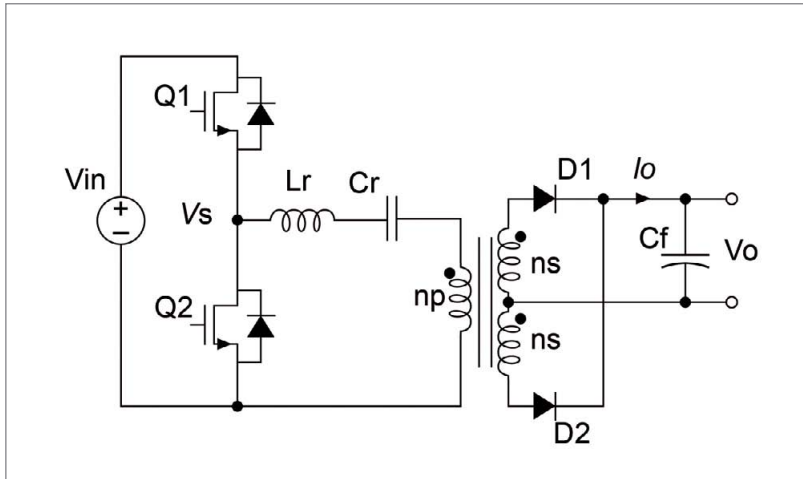

The peak current in the PFC inductor is given by:

$$i_{PK} = \frac{2 \cdot \sqrt{2} \cdot P_{OUT}}{V_{AC_{MIN}} \cdot \eta} \text{ [Amps Peak]}$$

The PFC inductor should be designed so that it does not saturate at  $i_{PK}$  and maximum operating temperature. This involves adequate sizing of the core and air-gap.

The back end stage consists of an LLC resonant converter to convert the DC bus voltage down to a DC output with constant current. The transformer is the core element which provides isolation and voltage conversion. This transformer incorporates high primary leakage inductance in order to provide the inductance that forms the resonant circuit with a capacitor connected in series with it. An alternative approach is to use a standard transformer design and add an external resonant inductor. This simplifies design but adds space and cost.

Figure 2 illustrates the basic LLC resonant converter circuit. The schematic in Figure 1 uses the same technique except that  $L_r$  is built into the transformer and  $C_r$  (which also provides DC blocking) appears at the other side of the primary. The secondary consists of two windings and two rectifier diodes. These are normally Schottky diode to minimize conduction losses, or in high current designs synchronous rectification MOSFETs may be used. Most of the ripple at the output is at twice the switching frequency which allows ceramic filter capacitors to be used in conjunction with an inductor to provide sufficiently low ripple at the output. In this system electrolytic capacitors are required only for smoothing the DC bus at the interface between the two stages. Since these are likely to have the shortest operating life, parts should be used that are rated for long life and high temperature. When temperature de-rated, these capacitors can meet the life requirements of the converter.

The half-bridge switches operate at 50% duty cycle and the output voltage is regulated by varying the switching frequency. An LED load can be represented by a voltage source with a series resistor. The current can also be regulated effectively by adjusting the frequency. The frequency will adjust to provide the required drive current for any number of LEDs connected to the output up to a maximum of the 60 V low voltage safety limit. The half-bridge resonant stage has two resonant frequencies; the first determined by the series inductor ( $L_r$ ) and resonant capacitor ( $C_r$ ) and the second determined by the transformer magnetizing inductance ( $L_m$ ) and the resonant capacitor. While the frequency remains in the inductive region the soft switching will occur.

### Resonant Converter Design

Although the resonant power supply design process can appear a little intimidating to engineers who are not familiar with it, it can be simplified to give confidence to go down this path. A simple model can be used to simulate the resonant circuit shown in Figure 3.

$V_{in}$  refers to the DC bus voltage which can be considered to be constant since it is regulated by the front end.  $V_{out}$  will be the maximum total voltage of the LED load which typically consists of a series/parallel array of individual high brightness white LEDs.  $R_{LOAD}$  is then calculated from the desired output current. The transformer turns ratio can be calculated from the equation:

$$n = \frac{V_{in}}{2 \cdot V_{out}}$$

**Figure 3:**  
LLC resonant simple model

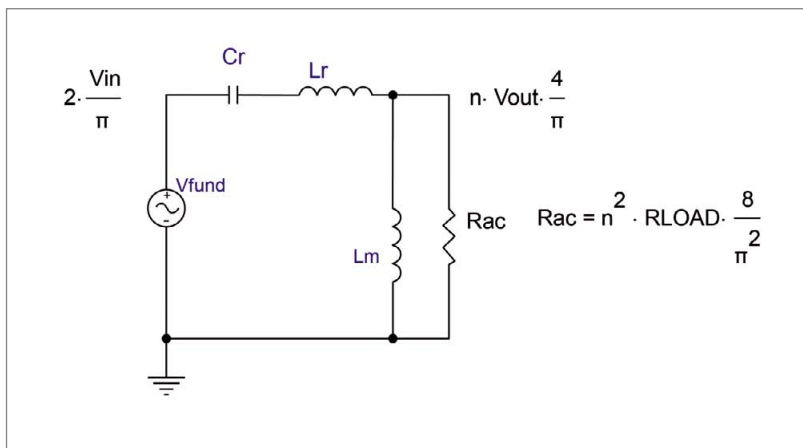

AC simulations can now be run to show the converter frequency response. A typical example is shown in Figure 4, which shows several response curves under various different load conditions.

$k$  is the ratio between the transformer magnetizing inductance  $L_m$  and the resonant inductance  $L_r$ . Smaller  $k$  value gives steeper gain curve, especially at the below resonant ZVS

**Figure 4:**  
Typical voltage conversion ratio of an LLC resonant converter

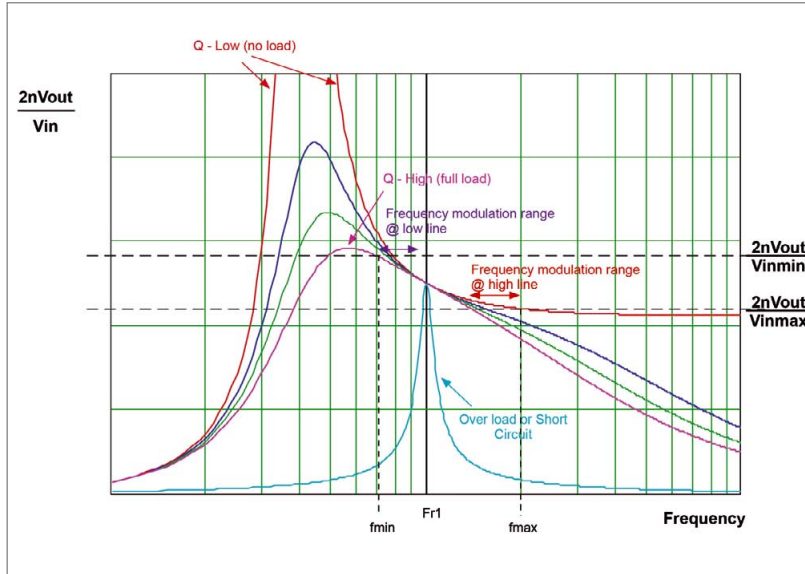

**Figure 5:**  
k factor

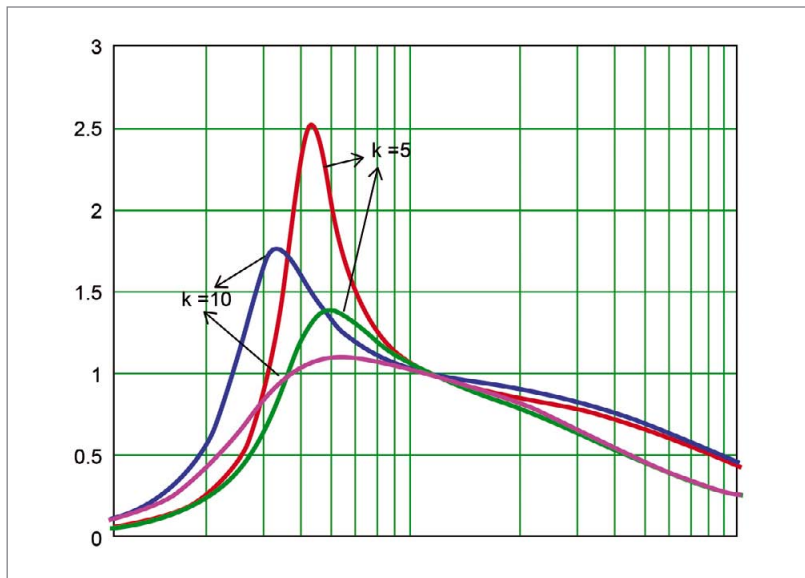

region as shown in Figure 5. The output voltage is more sensitive to frequency variation with smaller k factor.

A higher k value results in higher magnetic inductance and thus, lower magnetizing current in the transformer primary winding, resulting in lower circulating power losses. However, higher magnetic inductance could also cause non-ZVS switching at high line and zero load condition where the circulating current is too small to fully charge / discharge the VS node during dead-time.

As usual the design is a trade-off. The recommended range of k is from 3 to 10.

$L_r$  and  $C_r$  values can be determined by running several simulations or calculated

from the maximum Q value and desired resonant frequency  $F_{r1}$  using:

$$L_r = \frac{Q_{max} \cdot Rac}{2 \cdot \pi \cdot F_{r1}}$$

$$C_r = \frac{1}{2 \cdot \pi \cdot F_{r1} \cdot Q_{max} \cdot Rac}$$

To keep the converter working in soft switching mode, the operating point should always remain in the ZVS region as shown in Figure 4. The ZVS-ZCS boundary line is defined by the phase angle of  $Z_{in} \Phi(Z_{in}) = 0$ . This is the boundary condition between capacitive and inductive load where the imaginary part of  $Z_{in}$  is zero. With this condition the maximum Q can be calculated which allows the converter to stay in ZVS. The maximum Q happens at the minimum input voltage and the maximum load.

$$Q_{max} = \frac{1}{k} \cdot \sqrt{\frac{1+k \cdot \left(1 - \frac{1}{M_{max}^2}\right)}{M_{max}^2 - 1}} =$$

$$\frac{1}{k} \cdot \sqrt{\frac{1+k \cdot \left[1 - \frac{1}{\left(2 \cdot n \cdot \frac{V_{out}}{V_{in}}\right)^2}\right]}{\left(2 \cdot n \cdot \frac{V_{out}}{V_{in}}\right)^2 - 1}}$$

Where  $M_{max}$  is the maximum conversion ratio at the minimum input voltage given by:

$$M = \frac{V_{out}}{V_{in}} \cdot 2 \cdot n$$

The minimum switching frequency occurs at the maximum load with the previous calculated maximum  $Q_{max}$ . As  $Q_{max}$  is defined by  $I_m(Z_{in})=0$ ,

$$\left(x - \frac{1}{x} + \frac{x \cdot k}{1 + k^2 \cdot x^2 \cdot Q_{max}^2}\right) = 0$$

The  $F_{min}$  can be calculated with:

$$x_{min} = \frac{1}{\sqrt{1+k \cdot \left(1 - \frac{1}{M_{max}^2}\right)}} =$$

$$\frac{1}{\sqrt{1+k \cdot \left[1 - \frac{1}{\left(\frac{2n \cdot V_{out}}{V_{inmin}}\right)^2}\right]}}$$

$$F_{min} = x_{min} \cdot F_{r1}$$

Although these calculations may appear complicated at first glance, they can be easily placed in a spreadsheet or Mathcad script making it a simple matter to plug in different values to obtain desired results.

### Resonant Circuit Characteristics

The characteristics of an LLC resonant converter can be divided into three regions based on the three different modes of operation shown in Figure 6.

The first region is for switching frequency above the resonant frequency  $F_{r1}$ .

$$F_{r1} = \frac{1}{2\pi \sqrt{L_r \cdot C_r}}$$

**Figure 6:**  
Typical frequency response of an LLC resonant converter

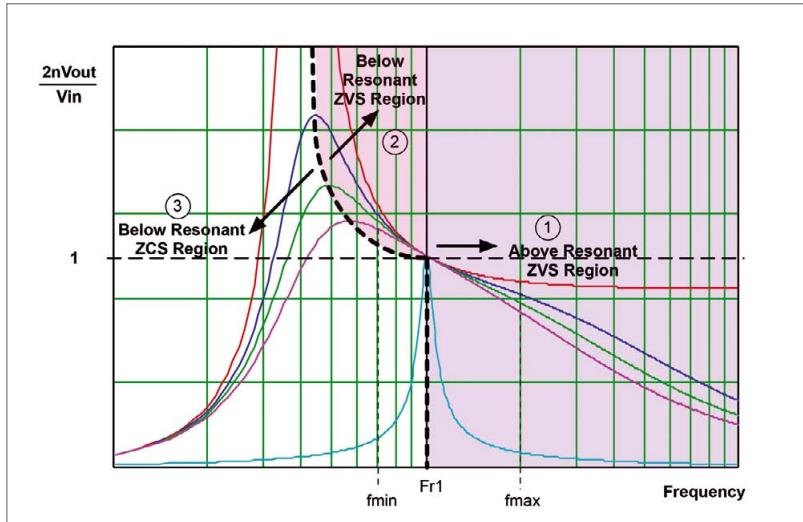

In region 1 of Figure 6 switching frequency is above the resonant frequency  $F_{r1}$ .  $L_m$  does not resonate with  $C_r$  it is clamped by the output voltage and acts as the load of the series resonant tank. This is the inductive load region where the converter is always under ZVS operation regardless of the load condition.

In region 2 the switching frequency is above the lower resonant frequency but below  $F_{r1}$ . The lower resonant frequency varies with load so the boundary of region 2 and region 3 traces the peaks of the load vs. gain curve series.

**Figure 7:**  
Typical waveform of above resonant ZVS switching

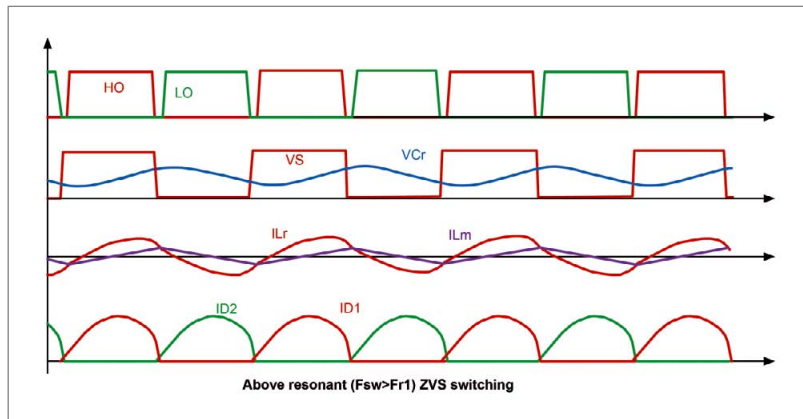

In this complex region the LLC resonant operation can be divided into two time intervals; in the first time interval  $L_r$  resonates with  $C_r$  and  $L_m$  and is clamped by output voltage. When the current in the resonant inductor  $L_r$  resonates back to the same level as the magnetizing current,  $L_r$  and  $C_r$  stop resonating.  $L_m$  now participates in the resonant operation and the second time interval begins. During this time interval the dominant resonant components become  $C_r$  and  $L_m$  in series with  $L_r$ . The ZVS operation in region 2 is guaranteed by operating the converter to the right side of the load gain curve.

**Figure 8:**  
Typical waveform of below resonant ZVS switching

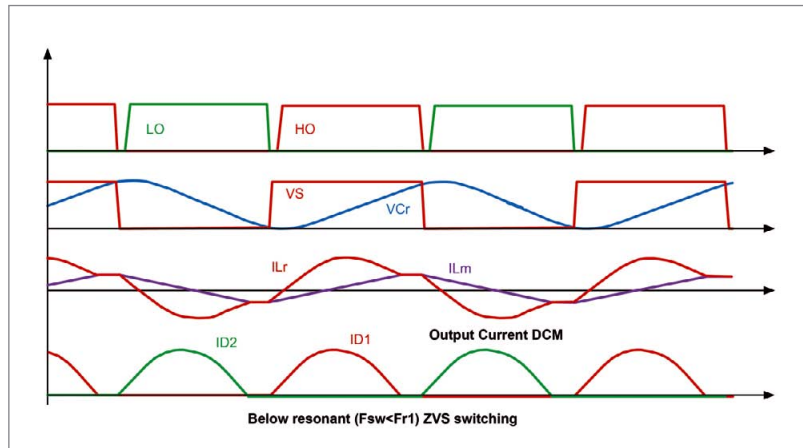

For a switching frequency below resonant  $F_{r1}$  operation could fall in either region 2 or region 3 depending on the load condition. In the ZCS range below  $F_{r1}$ , the LLC resonant converter operates in capacitive mode where the half bridge MOSFETs are hard switching with high switching losses. Operation in this region should be avoided.

**Figure 9:**  
Typical waveform of below resonant ZCS switching

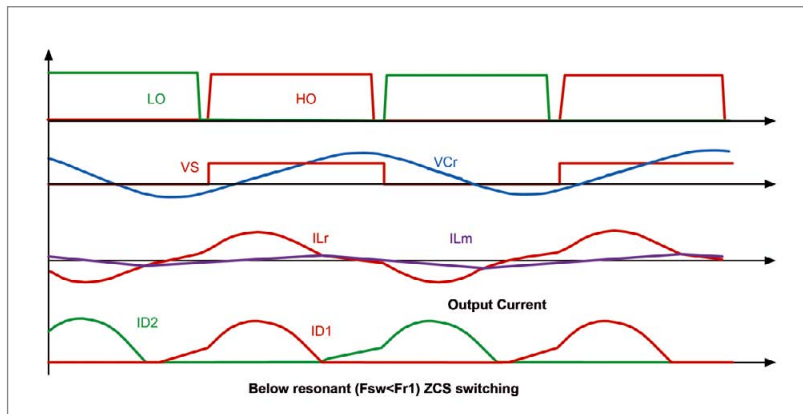

The waveforms in Figures 7, 8 and 9 indicate the behavior of the system in each of the operating regions.

The waveforms in Figure 8 indicate that the current in the secondary rectifier diodes moves from continuous current mode (CCM) to discontinuous current mode (DCM) when the switching frequency moves from above resonant ZVS to below resonant ZVS due to load increasing. The ripple voltage at the resonant capacitor  $C_r$  also increases.

**Figure 10:**  
Complete resonant LED driver schematic

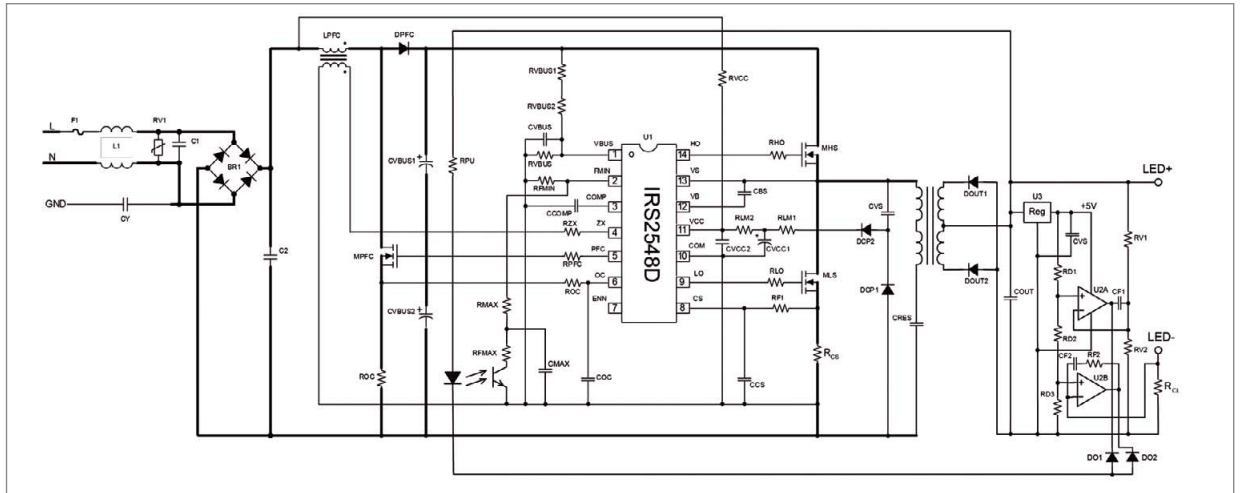

In ZCS mode the half bridge MOSFETs are turned off under zero current condition. The turn-on of the two switches is hard switched (non ZVS); therefore the turn-on switching loss is high. The resonant capacitor Cr also has high voltage stress. Operation in this mode should be avoided!

With a regulated DC bus voltage supplied from the PFC stage the converter varies switching frequency to regulate the output voltage and current over load range keeping the same conversion ratio over the family of curves with different Q. Given a fixed load condition the converter adjusts the switching frequency along that load line to regulate the output over input voltage range.

To obtain long operating life it is critical to select an adequately rated resonant capacitor Cr according to the capacitance value together with voltage and ripple current rating. Polypropylene film capacitors are preferred for lower power loss. These parts are rated at DC voltage or 50-60 Hz AC voltage with de-rating at higher frequencies. The ability to withstand voltage at high frequency is limited by thermal (power dissipation) and peak current capability.

### Selection of Critical Components

The standard half-bridge equation for the transformer turns number calculation is used here

$$N_p = \frac{V_{n \min} \cdot D_{\max}}{2 \cdot \Delta B \cdot A_e \cdot F_{\min}}$$

Several methods exist for the transformer design procedure and different engineers have their own preferences often according to experience. One can use the core area product method to determine core size and work from there or choose a core size from manufacturers recommendations based on throughput power at various frequencies. The complexity in transformer design comes in incorporating the Lr. This is normally achieved by use of a two section bobbin that separates the primary and secondary windings in order to reduce coupling and introduce leakage inductance. This is hard to calculate, which means that often a transformer is constructed and then the LR measured so that the engineer can go back to the simulation and recalculate the circuit parameters based on the actual transformer characteristics.

Finally, once the hard part of the design is done a control IC needs to be chosen. Component count and size can be reduced by using a “combo” PFC plus half bridge driver IC such as the IRS2548D. This part contains all the functionality required for controlling the front end PFC circuit as well as the resonant half bridge incorporating a floating high side gate driver for the upper bridge MOSFET. The half bridge frequency can be adjusted by a simple feedback circuit using an opto isolator. Output current is sensed through a shunt resistor and compared to a reference using an opamp located at the secondary. The error signal drives the opto diode and the transistor sinks

current from the IRS2548D frequency control input to increase the frequency and therefore lower the output current to the required level. An additional voltage sensing circuit may also be added to prevent the output voltage from exceeding a set level under an open circuit condition. There are several ICs available specifically designed for such applications that incorporate both voltage and current feedback opamps with an accurate reference with the outputs combined to drive a single opto isolator.

Figure 10 shows a complete implementation illustrating low component count. Size can be minimized by optimization of the PFC inductor and transformer.

### Conclusions

The Flyback converter is particularly popular for its simplicity and low cost. In isolated LED drivers below 50 W the Flyback converter offers the best solution. However, unlike the Flyback, the resonant converter becomes more efficient at higher power levels while the Flyback becomes bulky and less efficient. Where high power density and small size are required the resonant topology provides a viable alternative to more traditional topologies. When paying heed to some major design rules, design of a resonant converter is not too complicated, and costs are kept well within reasonable limits. All in all, the advantages clearly justify the application of this topology when exceeding a power limit of 50 W. ■

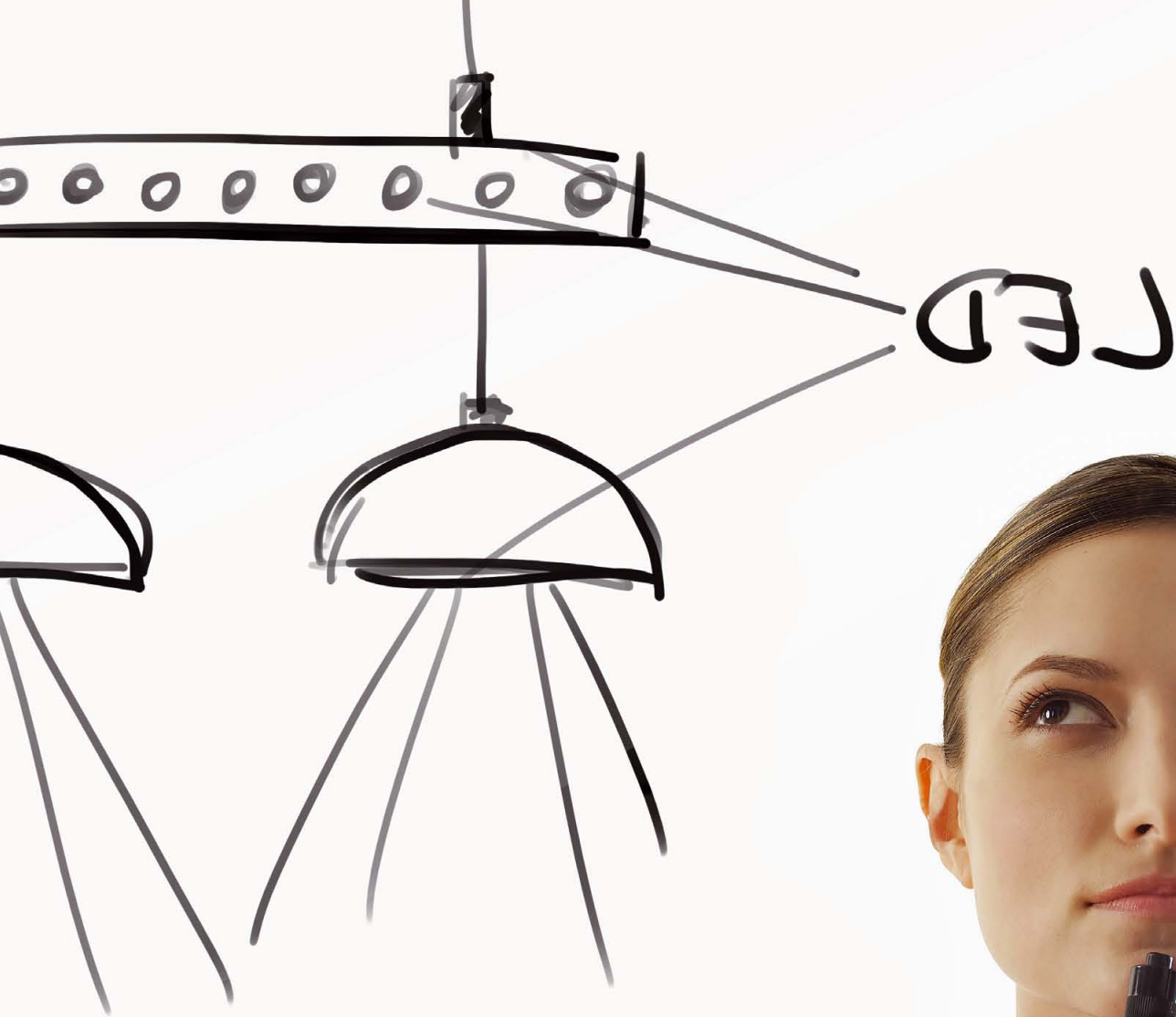

You have the idea,  
we have the solution.

Rely on our extensive experience when implementing your LED lighting idea. We provide customized solutions and support you professionally in the realization of your project. Put us to the challenge!

For more information, please see [www.ledlightforyou.com/ideas](http://www.ledlightforyou.com/ideas)

The network for LED lighting technology.

**LED**  **Light for you**  
powered by OSRAM

# DC/DC Converters Offer Flexibility when Designing LED Drivers

DC/DC converters are used in many of today's applications and products. They also offer some advantages for developing LED drivers. Steve Roberts, Technical Director of the RECOM group explains these advantages and shows when a DC/DC converter is the first choice.

For efficient and reliable LED lighting, the optimum matching of the driver to the LED must be taken into account besides a simple selection according to the required constant current. Until now it was common to always use an AC powered LED ballast, usually supplied as a kit with the purchase of the LEDs. However, LEDs offer solutions

to many new applications that require dimming or mood lighting and a simple AC ballast is only one solution. In the future, it will become more important to offer a construction kit type lighting system with different options for various external control systems. Which control bus protocol will win the widest acceptance is still open, so it is important to be

able to react flexibly to market developments – for example, today an analogue 10 V dimming control may be requested while tomorrow a color-changing solution with a DMX interface is all the rage. DC/DC LED drivers offer this flexibility already. The control interface can quickly and inexpensively adapt – even for low volume projects.

**Figure 1:**  
Typical RGBW control system with the building block solution plus a microcontroller that can interface either with analogue or PWM signals to the drivers

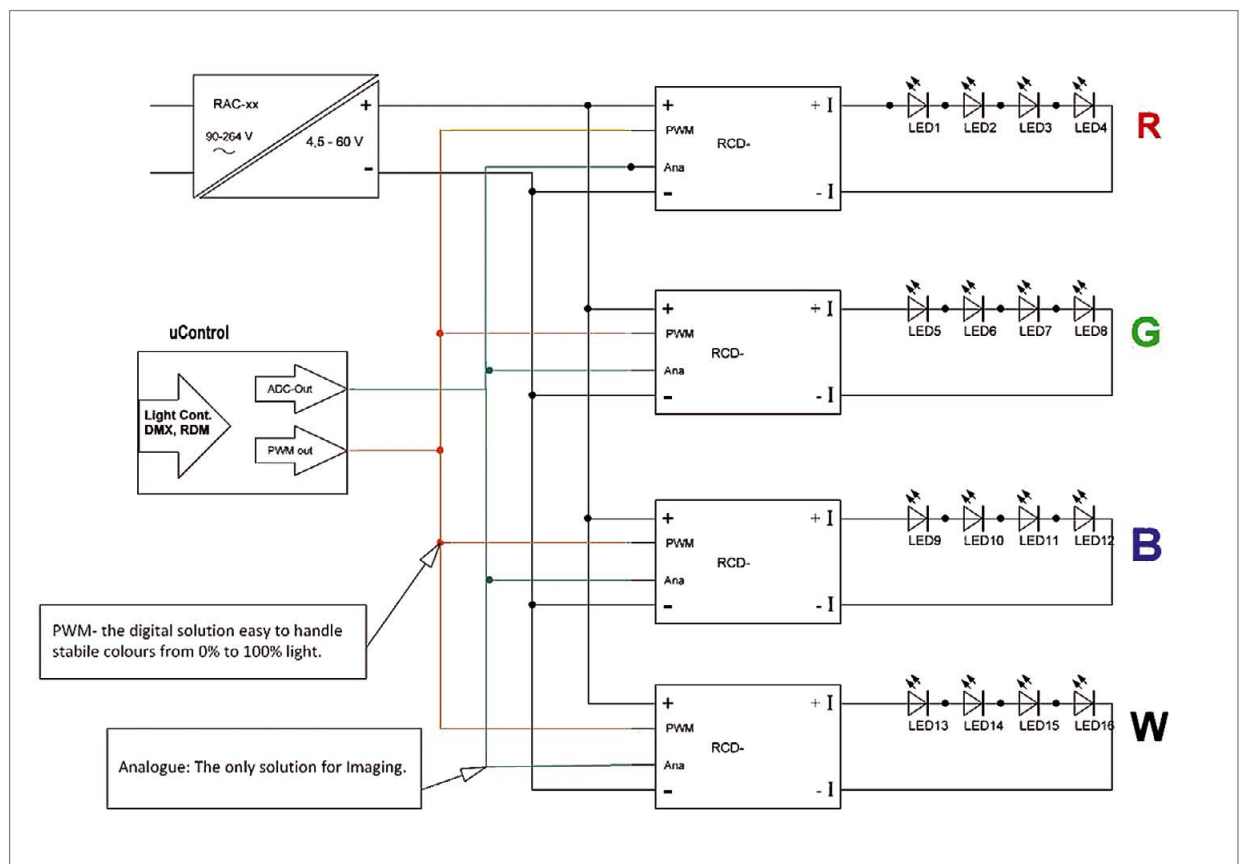



### Flexible Modular DC/DC Solutions vs. AC Power Supplies

Every customer wants to have a solution that best matches their application. There are many lighting applications where a specially developed product makes sense and also covers the high development costs. On the other hand, there are many more applications with low volumes of up to, say, a thousand drivers, where a custom AC solution does not make financial sense. Typical problems that face the power supply designer are that the existing ready-made solution doesn't deliver the required power, or has four, instead of the required eight channels, or is too large to fit into the luminaire or does not feature a matching interface (for example analogue instead of DALI). The development of custom AC ballast is not economically feasible and therefore compromises must be made to the specification. However, DC/DC LED drivers offer flexible solutions when used as standard building blocks in a larger custom system. The user can assemble the required power supply quickly and by choosing the right building blocks can reduce the required components to a minimum, through which not only the BOM is simplified, but also the delivery times are kept short – a key factor in the rapidly moving illumination industry.

In the example shown in Figure 1, standard products can be controlled by either DMX or DALI bus protocols by using a microcontroller as a universal interface, many of which have the control protocol already imbedded as firmware. DMX is universally used in stage lighting and DALI (Digital

Addressable Lighting Interface) is one of the widest accepted interface standards for white light electronic ballasts. Both systems offer a multiplicity of corresponding dimmers, switches and other controllers. These bus interfaces can also be purchased as standard modules and can thus be combined with standard drivers to realize a custom solution using standard components. Since the drivers feature both analogue and digital dimming control, they will work with any standard interface.

### DC/DC Drivers Improve the Overall System Efficiency

LEDs are efficient light sources, but nevertheless they dissipate power in the form of heat. Additionally, AC ballasts can also generate heat, adding to the temperature stress within the light fitting. LEDs are semiconductors which are very sensitive to over-temperatures. Therefore it is important to keep the LED temperature as low as possible, in order not to shorten the well-known quality of a long LED-lifetime.

To keep the operating temperature of LED-systems under control, it is not enough to just design effective heat sinking; it also helps to reduce the heat generated by the drivers because the lower the losses, the lower the dissipated power. Dissipated power is dependent on driver efficiency. In other words, driver efficiency plays an important role in solid state lighting systems, not just because we want an efficient light, but also because it strongly influences thermal management.

Which LED power supply topology offers the highest system-efficiency? The simplest solution is to use an AC ballast to power each LED from the mains AC supply. But an alternative is to use a central AC/DC power supply to power several DC/DC LED drivers. This topology has big advantages in many applications.

Low power AC ballasts for 6W LEDs (equivalent to a 60W incandescent) normally offer efficiencies of approximately 65% (Figure2). This means that 35% of the total energy will be lost as heat. Altogether the efficiency of the complete light fitting sinks considerably further, if one still takes the losses of the LED through the increased temperature, the optical losses and further light-performance-reductions through reflectors into account. The higher losses also conceivably have an influence on the lifespan of the light.

With the introduction of a 20 W constant voltage power supply with PFC (power factor correction), the power supply efficiency rises to approximately 88%. The LEDs are individually powered (and dimmable) via DC/DC LED drivers that have a typical efficiency of 96%. This yields a total system-efficiency of approximately 84% (0.88 x 0.96). The main loss of only 12% (a third of the previous example) occurs away from the LEDs, with only a little over 1% being dissipated close to the LEDs, which leads to a much longer LED lifespan. PF correction is stipulated for AC power supplies >25 W in the lighting industry, which means that many low power AC ballasts could be legally installed without PFC but yet have a significant combined interference on the mains supply. With the indicated 2-stage concept shown in Figure 3, the central power supply with active PFC will typically have a power factor of >0.95.

**Figure 2:**  
LED-system with AC ballasts

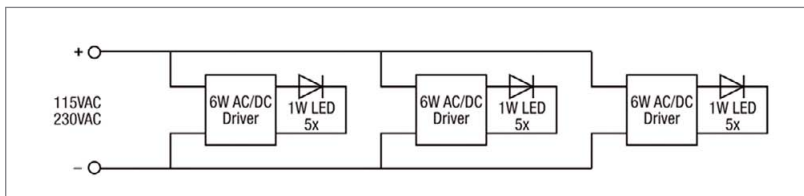

**Figure 3:**  
High efficiency LED-system with AC/DC supply and separate DC/DC drivers

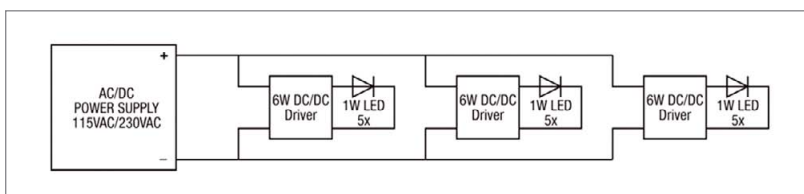

### Ceramic Capacitors Increase Reliability

The most critical component affecting the lifespan of a power supply is usually the electrolytic capacitors. Despite this, it is common to find DC/DC LED drivers at the lower end of the

**Figure 4:**  
DC/DC driver with ceramic capacitors (left) compared to a competitor's product with electrolytic capacitors (right). The ECAP is the large brown object

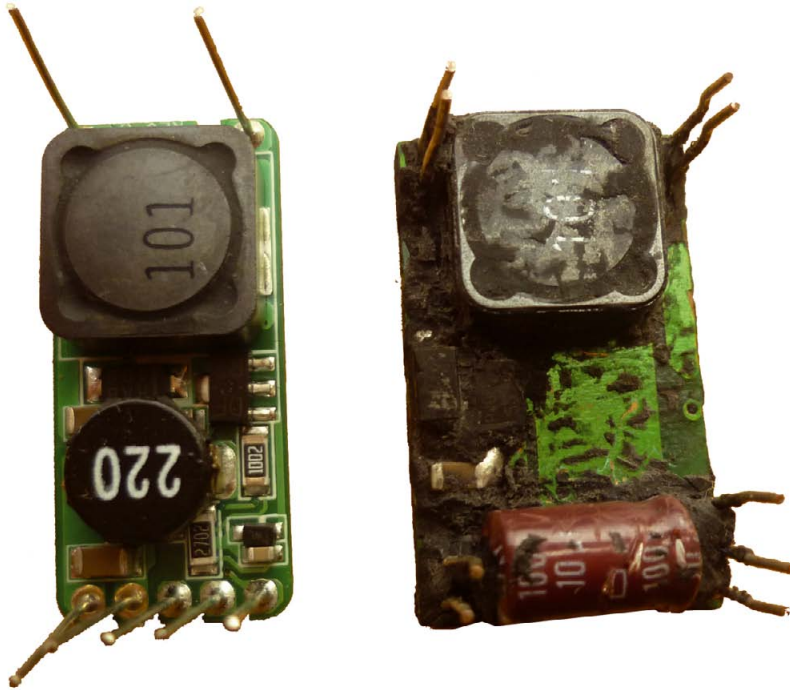

market that still use electrolytic capacitors because of their low cost. The end customers must bear the costs of replacing units that have failed in the field because the supplier usually guarantees replacement-only and does not cover any resulting costs. But the biggest loss is to the end customer's image.

Why are Electrolytic capacitors ("ECAPs") such a problem? ECAPs contain a liquid electrolyte that can boil if the capacitor overheats or dries out at elevated temperatures. If the

capacitor is well de-rated and used in benign conditions, it will last a long time, but in order to save costs many low price suppliers run the capacitors close to their limits. If a driver fitted with ECAPs is used adjacent to the hot heat sink of an LED light, a premature failure is almost inevitable. For this reason, quality manufacturers only use ceramic condensers in their DC/DC LED drivers which do not have a liquid electrolyte and do not suffer such rapid degradation at elevated temperatures.

**Figure 5:**  
The compact RCD-24-PL series is available with either class A (below) or class B filters (above) built-in EMC filters



## EMC-Filter Affects Design and Price

LED lighting is strictly regulated regarding Electromagnetic Compatibility (EMC). The strict limits laid out in standards such as EN55022 and EN55015 are not to be underestimated. Dependent on the application area of the LED driver, there are different standards that must be fulfilled. For example, for DC/DC applications, the requirement is either EN55022 Class A for industrial applications or the more stringent Class B for domestic uses. EMC information is usually missing in many datasheets, and the costs of redesigning and adding external filters after a product has failed the EMC test can be very expensive. The EMC filter's effect on the design, size, weight and price is often overlooked. And any change to the system configuration may need costly re-qualification. To simplify this process, RECOM offers SMT mounting DC/DC drivers with built-in Class A or Class B EMC filters.

## Safe Extra Low Voltage (SELV)

Electronics classed as SELV, which in practice means no voltages above 60 VDC, require no protection against direct and indirect touch to any of the conductive parts. This makes meeting the safety standards relatively easy. This is a big advantage, since safety-isolation usually increases the costs considerably and can impair the thermal cooling, which leads to a shorter lifespan. As SELV is a fixed limit, it makes economic sense to use the maximum voltage permitted to drive the maximum length of LED chain. However, due to the limitations in IC construction, most DC/DC drivers can only be used up to around 40 V and very few can be used above 48 V. This is a problem as more and more LED manufacturers are offering new high voltage LED arrays that offer the user considerable advantages in terms of light intensity, ease of mounting and efficacy. Many of these new generation arrays require forward voltages of up to 50 V. In order to accommodate these arrays, RECOM

**Figure 6:**  
A selection of  
RECOM's DC/DC-  
driver designs



has developed the RCD-48 series which can drive these high power LEDs at up to 1.2 A constant current and up to 56 V forward voltage (67 W).

### Buck and Buck/Boost Drivers

Buck drivers, like the RCD-24, are a good solution if the input voltage is higher than the LED string voltage. The driver efficiently converts a higher input voltage down to a lower output voltage with higher constant current. An example might make this clear: say we want to drive three 500 mA LEDs from a 24 V DC supply. A single LED requires 3.3 V forward voltage, so three LEDs in series require about 10 V. Buck drivers are highly efficient converters (>96%), so the 5 W LED load will also draw 5 W from the 24 V supply, or about 210 mA.

A buck/boost driver is required if the input voltage is not fixed, for example, from a lead acid battery. If the battery is fully charged it may deliver 14 V, so we could still use the buck driver as in the previous example. But if the battery is fully discharged it will deliver 9 V or less and the buck driver solution will not work. The RBD-12 buck/boost design offers a constant 10 V / 0.5 A output over an input voltage from 8 V up to 36 V, so it could be used with both 12 V and 24 V battery solutions. In addition, the buck/boost can be used in pure boost mode to drive up to seven 500 mA LEDs from a 12 V supply with an output voltage of 24 V. This is useful for photovoltaic (PV) applications and the RBD-12 has been designed to be compatible with PV panels, so, for example, the panel itself can be used as a light sensor to automatically switch on the LEDs at dusk.

The selection of the optimum LED driver is thus very dependent on the required LED application. The RCD-24 is suitable for general purpose applications, the RCD-48 is better for the latest generation higher voltage LED arrays and the RBD-12 has the advantage of regulating a variable input voltage that is both above and below the LED forward voltage.

### Matching the LED Driver to a Wide Variety of Applications

There are as many LED lighting solutions as there are applications and the rate of new applications within the lighting spectrum shows no sign of slowing down. DC/DC LED drivers find uses in many widely different areas - from street lighting to transport applications, in photovoltaic systems, in demanding marine and aeronautics illumination or for mobile battery-powered applications, to name but a few.

Depending on the application, the way that the driver is fitted can be very different. Therefore, it is a big advantage if the driver is available with different mounting options to match the miscellaneous requirements of the application. DC/DC LED drivers are available in compact dimensions for SMT mounting, or in sealed cases for PCB through hole assembly or with wired connections for building into lighting fittings or fitting above suspended ceilings. Modules are available with plastic cases, robust metal-cases or as open-frame versions, so these DC/DC drivers can be found to fit into any LED-lighting system. Moreover, such drivers are dimmable with both digital PWM and analogue control systems and offer auxiliary reference output voltages to power external sensors or to easily permit manual potentiometer dimming. ■

# Annual *LED professional Review (LpR)* Article Index 2011

## Events

<b>The Display Industry Drives OLED Technology</b> by Alan R. Mills, LED professional	LpR 23 – Jan/Feb 2011	p 24
<b>LED Investor Forum 2011 - Santa Clara</b> by Alan R. Miles, LED professional	LpR 25 – May/June 2011	p 26
<b>LpS 2011 Advisory Board Q &amp; A</b> by Siegfried Luger, LED professional	LpR 27 – Sept/Oct 2011	p 26
<b>LED Lighting Taiwan 2011 - Photonics is LEDs</b> by Arno Grabher-Meyer, LED professional	LpR 27 – Sept/Oct 2011	p 28
<b>LpS 2011 Fascinated LED Lighting Specialists from All Over the World</b> by Arno Grabher-Meyer, LED professional	LpR 28 – Nov/Dec 2011	p 26

## Interviews

<b>The Future of LED Systems is Digital</b> Interview with Peter Deixler, Philips Eindhoven by Arno Grabher-Meyer, LED professional	LpR 23 – Jan/Feb 2011	p 28
<b>The Optical Plastics Make a Difference to a Lens</b> Interview with Peter Jackson and Tsuyoshi Okii from Styron LLC by Arno Grabher-Meyer, LED professional	LpR 24 – March/April 2011	p 28
<b>LED Street Lighting - About Standards, Challenges and Misconceptions</b> Interview with Prof. Tran Quoc Khanh, TU Darmstadt by Siegfried Luger and Arno Grabher-Meyer, LED professional	LpR 25 – May/June 2011	p 30
<b>Insights Into Recent LED Developments</b> Interview with Eric Virey, Yole Développement by Siegfried Luger and Arno Grabher-Meyer, LED professional	LpR 26 – July/Aug 2011	p 24
<b>New Technology Concepts in the LED Lighting Industry</b> Interview with Thomas Zabel, e.lumix by Siegfried Luger, LED professional	LpR 27 – Sept/Oct 2011	p 38
<b>New Aspects of AC LED Technologies</b> Interview with Manuel Zarauza, Managing Dir., Seoul Semiconductor by Siegfried Luger, LED professional	LpR 28 – Nov/Dec 2011	p 40

## Applications

<b>Intelligent Lighting (Part II): From Definition to Implementation</b> by Osama Mannan, Future Lighting Solutions	LpR 23 – Jan/Feb 2011	p 32
<b>Active Cooled 75 to 100 W Equivalent LED Retrofit Bulbs</b> by Istvan Bakk, Tridonic, and Brandon Noska, Nuventix	LpR 24 – March/April 2011	p 32
<b>Re-Thinking a New Power and Control System for LED Lighting</b> by Mark Covaro, Redwood Systems	LpR 24 – March/April 2011	p 38
<b>DC Microgrids and SSL - Key Components for Zero Net Energy Buildings</b> by Brian T. Patterson, EMerge Alliance and Karen Lee, Osram Sylvania	LpR 25 – May/June 2011	p 34

## Technology

<b>Understanding the Pitfalls of Tunable White Light LED Systems</b> by Madhan Kumar, Sachin Gupta, Cypress Semiconductors	LpR 23 – Jan/Feb 2011	p 38
<b>Growing GaN Epi Layers on 200 mm Silicon Substrates for LED Applications</b> by Kai Cheng, Johan Dekoster, imec, and Sung Won Jun, Jose-Ignacio Del-Agua-Borniquel, App. Materials	LpR 26 – July/Aug 2011	p 28
<b>Influence of the Phosphor Selection on Lighting Quality</b> by Dan O'Hare and Jonathan H. Melman, Intematix	LpR 26 – July/Aug 2011	p 34
<b>Sapphire Wafer Wet Etching versus Dry Etching</b> by Carolyn Gruske & Derek Mendes, Imtec Acculine Inc.	LpR 27 – Sept/Oct 2011	p 42

# Annual *LED professional Review (LpR)* Article Index 2011

## Characterization

- Advanced Lighting Technology Needs an Advanced Color Rendition Metric** LpR 24 – March/April 2011 p 44  
by Artūras Žukauskas, Rimantas Vaicekauskas, Vilnius Univ., Michael Shur, Rensselaer Polytechnic Inst.

## Optics

- LED Secondary Optics Technology** LpR 28 – Nov/Dec 2011 p 44  
by Molly Lin, Marketing Section Manager, Ledlink
- Print-Optical Technology – Manufacture LED Lenses by Stacking Droplets-On-Demand** LpR 28 – Nov/Dec 2011 p 48  
by Richard de Vrie, CEO, Kurt Blessing, CTO, LUXeXceL Group B.V.

## Electronics

- Triac Dimmable Primary Side Regulated Flyback** LpR 23 – Jan/Feb 2011 p 42  
by Michael Weirich, Fairchild Global Power ResourceSM Center EP
- Facts about Dimming** LpR 23 – Jan/Feb 2011 p 48  
by Gregg Sheehan, Light-Based Technologies
- Charge Controlled LED Drivers** LpR 23 – Jan/Feb 2011 p 56  
by Jens Gohring, diltronics
- Needed Accuracy of an LED Power Supply** LpR 23 – Jan/Feb 2011 p 60  
by Christopher Richardson, National Semiconductors
- Sophisticated LED Driver Enhances Quality in Full Color Video Displays** LpR 24 – March/April 2011 p 50  
by L. Pistoni, M. Merisio, F. Lissoni, and W. Trovo, ST Microelectronics
- LED Driver Innovations for High-Performance Signage** LpR 25 – May/June 2011 p 40  
by Roland Gehrmann, Toshiba Consumer & Industrial ICs
- Highly Efficient and Reliable Power Supply for LED Street Lighting** LpR 26 – July/Aug 2011 p 40  
by Wonseok Kang and Sungmo Young, Fairchild Semiconductor
- LED Drivers Help to Make LED Lighting Costs Competitive without Compromising Quality** LpR 26 – July/Aug 2011 p 44  
by Steve Roberts, Recom
- LED Driving Techniques to Hit Power Efficiency Targets of TV Backlight Systems** LpR 26 – July/Aug 2011 p 48  
by Werner Schögler, Markus Luidolt, Manfred Pauritsch and Peter Rust, austriamicrosystems AG
- An Advanced and Complete LED Driving Solution** LpR 27 – Sept/Oct 2011 p 48  
by Luigi Pistoni & Massimiliano Merisio, STMicroelectronics
- High-Efficient, High-Power Multi-Channel LED Driver** LpR 27 – Sept/Oct 2011 p 54  
by Winfried Beyer & Stephan Gruber, exscitron GmbH

## Thermal Management

- Cooling High Power LEDs** LpR 24 – March/April 2011 p 54  
by Norbert Engelberts, Advanced Thermal Solutions
- LED Cooling in Harsh Environments with Synthetic Jet Technology** LpR 25 – May/June 2011 p 44  
by Markus Schwickert and Brandon Noska, Nuventix
- Thermal Management of LED Lamps** LpR 25 – May/June 2011 p 48  
by A.Motoya, M. Kai, Y. Manabe and S.Shida, Panasonic Corp.
- Effective LED Replacement Bulb Cooling by Passive Convection** LpR 28 – Nov/Dec 2011 p 54  
by David Horn, CTO, Ronan Le Toquin, Tech. Director, Switch Lighting

## Special Topics

- HB-LED Alert Device with Intense Light Output** LpR 25 – May/June 2011 p 54  
by Jerry Vereen, Egret Technologies
- High Brightness LEDs on FR4 Laminates** LpR 27 – Sept/Oct 2011 p 62  
by Gerhard Neumann, melecs GmbH & Co KG

# Imprint

LED professional Review (LpR)  
ISSN 1993-890X

## Publisher

Luger Research e.U.  
Institute for Innovation & Technology  
dept. LED professional  
Moosmahdstrasse 30  
A 6850 Dornbirn, Austria / Europe

phone +43 5572 394 489  
fax +43 5572 394 489 90  
editors@led-professional.com  
www.led-professional.com

## Publishing Editors

Siegfried Luger  
Arno Grabher-Meyer

phone +43 5572 394 489  
phone +43 5572 394 489-18  
editors@led-professional.com

## Int. Account Manager

Theresa Koenig

phone +43 5572 394 489-20  
theresa.koenig@led-professional.com

## Front-page picture

Image: Arno Grabher-Meyer, LED professional, Optodrive LED Module "Clara"  
Artwork: Thomas Klobassa, ©LED professional 2012

## Copyrights – Luger Research e.U.

The editors make every reasonable effort to verify the information published, but Luger Research e.U. assumes no responsibility for the validity of any manufacturers, non profit organizations or individuals claims or statements. Luger Research e.U. does not assume and hereby disclaims any liability to any person for any loss or damage caused by errors or omissions in the material contained herein, regardless of whether such errors result from negligence, accident or any other cause whatsoever. You may not copy, reproduce, republish, download, post, broadcast, transmit, make available to the public, or otherwise use LED professional Review (LpR) content without prior written consent from Luger Research e.U. – Institute for Innovation & Technology, Austria. ■



## LED professional Review (LpR) - Annual Subscriptions

### LpR Digital Magazine

- 6 issues
- pdf download
- high resolution pictures and graphs
- printable
- commercial use
- access to all previous issues
- Euro 78.80

<http://www.led-professional.com/subscription>

### LpR Printed Magazine

- 6 issues
- Euro 158.40

Next LpR Issue - March/April 2012  
Drivers and System Integration

**LED** | SYMPOSIUM  
professional | +EXPO  
**LpS 2012**



**LED Lighting Technologies**  
International Winning Approaches

**25-27 SEPTEMBER 2012**  
**BREGENZ | AUSTRIA**

**CALL FOR PAPERS**  
[www.lps2012.com](http://www.lps2012.com)

### CONTACT:

LUGER RESEARCH | Moosmahdstrasse 30 | 6850 Dornbirn  
T +43 5572 39 44 89 | F +43 5572 39 44 89 90  
[info@lps2012.com](mailto:info@lps2012.com) | [www.lps2012.com](http://www.lps2012.com)

**e:lumix**  
Technologie AG

**OSRAM**  
Opto Semiconductors

**TRIDONIC**  
▼ engineering your ideas

We bring quality to light.

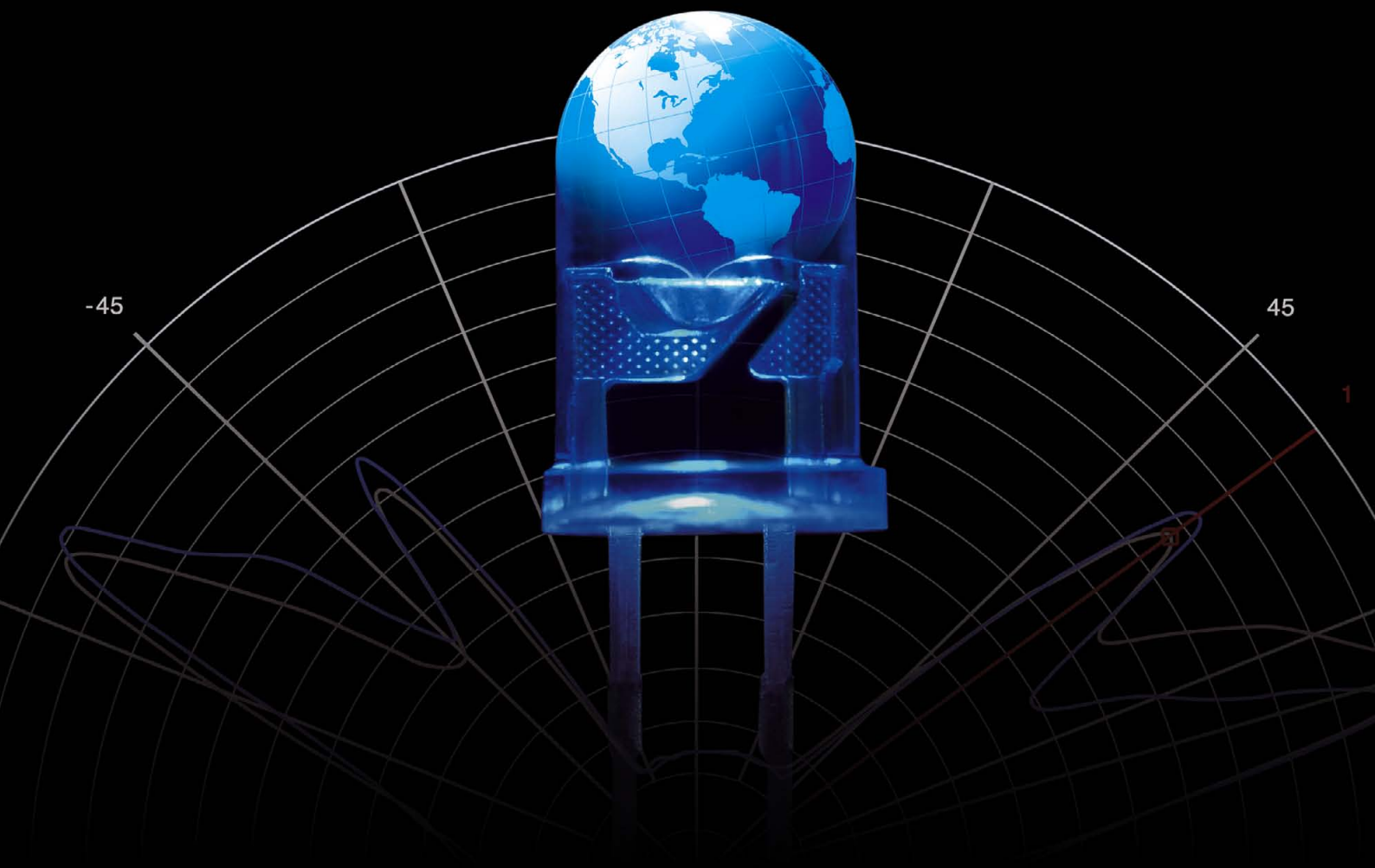

## LED test & measurement solutions from the world leader

Instrument Systems continues to set the benchmark in LED metrology. Whether testing individual LEDs (standard or high-power), LED modules, or OLEDs - the global LED industry relies on us to engineer superior measurement equipment for high-speed production testing and high-performance R&D and QC applications.



### Our instruments provide accurate and reliable results as per CIE recommendations and methods:

- Luminous flux [lm], luminous intensity [cd], and luminance [cd/m<sup>2</sup>]
- Chromaticity coordinates x,y,z and u'v'
- Color temperature and color rendering index
- Dominant wavelength and spectral data
- Spatial radiation pattern

 **Instrument  
Systems**  
light measurement



# LUXEON®

## Light that works

In shops and offices, in tunnels and on roadways, LUXEON works. With unparalleled efficiency, quality of light and reliability, the LUXEON portfolio simplifies your solutions and shortens your development time.

Learn more about how the LUXEON portfolio can help you, visit us at

[www.luxeon.com](http://www.luxeon.com)



# LUXEON®

BY PHILIPS LUMILEDS